

# SPECIFICATION

## FOR APPRONAL

Customer : \_\_\_\_\_  
Product Name : Microphone  
Model Name : VS6027S42CL120  
Drawing No. : VS20230828009

### Signature of Voice

Approved by	Checkde by	Issued by	Date



Address: No 96 Mogao Dongqian Lake Industrial Area ningbo, China  
Tel: 0086-0574-87773030; Fax: 0086-0574-87471600 P.C. 315121  
<http://www.nbvoise.com> Email: sales@nbvoise.com

## Table of contents

1. Revision
2. Scope
3. General Characteristics
4. Electrical and Acoustic Characteristics.
5. Measurement Method & Frequency Response curve
6. Dimensions

### 1. Revision

Rev.No.	Date	Page	Description of Revision
1.0	2023/8/26		Preliminary

Specification for Microphone		Page	2/4
		Revision No.	1.0
Model No.:	VS6027S42CL120	Drawing No.	VS20230828009

## 2. Scope

This specification applies electret condenser microphone.

## 3. General Characteristics

- 3.1 Out-Diameter : 6 mm
- 3.2 Height : 2.7 mm
- 3.3 Weight : 0.5 g
- 3.4 Operating Temperature : -30~+60°C without loss of function
- 3.5 Store Temperature : -40~+70°C without loss of function

## 4. Electrical and Acoustic Characteristics.

Test condition :5 ~ 35 °C Temp., 35% ~85% RH,86~106 kPa 1kHz , RL=2.2KΩ

No	Items	Specification
1	Directivity	Omni-directional
2	Sensitivity (S)	-42dB±3dB (1KHZ, 0dB=1V/pa )
3	Power Supply Voltage(Vs)	2.0V
4	Output impedance (RL)	2.2 KΩ
5	Operating Voltage	1-10 V
6	Sensitivity reduction within 1.5V	-3dB
7	Frequency	100-16,000Hz
8	Max. Current Consumption	0.5 mA
9	Min S/N ratio	58 dB
10	Material	AL
11	Environmental Regulations	RoHS

We use "Pascal (Pa)" indication of sensitivity as per the recommendation of I.E.C.(International Electro technical Commission).The Sensitivity of "Pa" will increase 20dB comparing with "ubar" indication. Example: -60dB (0dB=1V/ubar) =-40dB (1V/Pa)

### 5. Measurement Method & Frequency Response curve

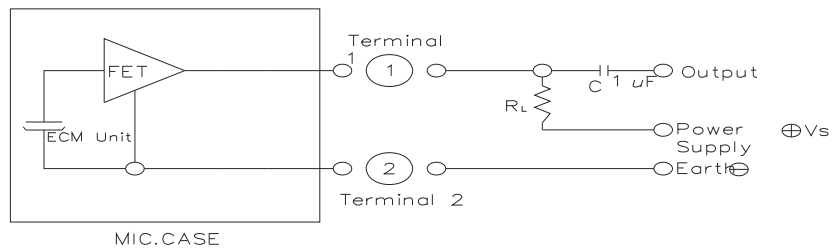
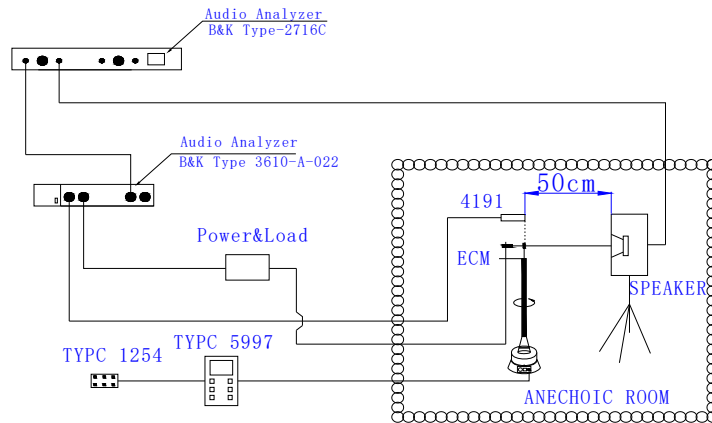

Vs: 2.0V RL: 2.2KΩ

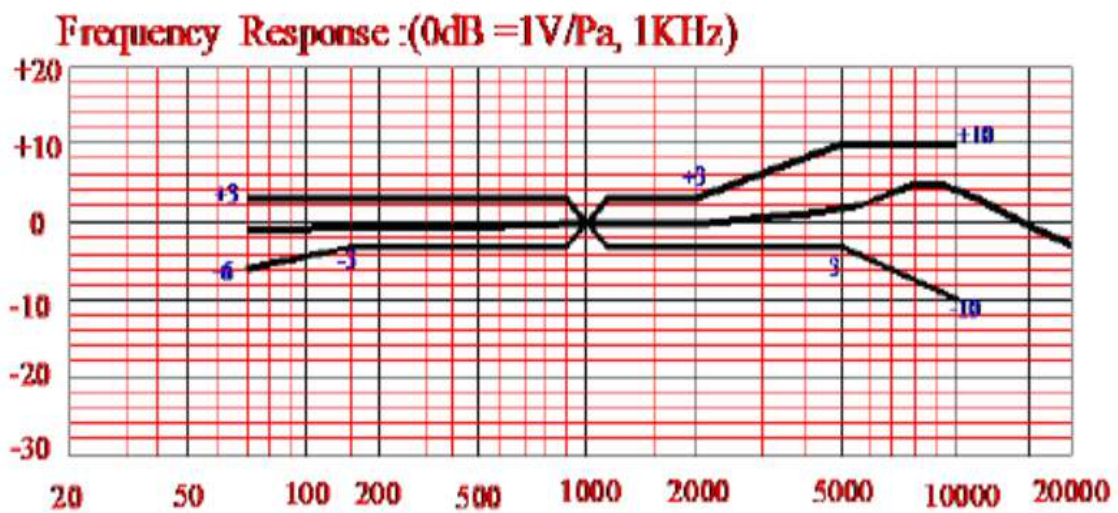

# Specification for Microphone

Page

4/4

Model No.: VS6027S42CL120

Revision No.

1.0

Drawing No.

VS20230828009

## 6. Dimensions

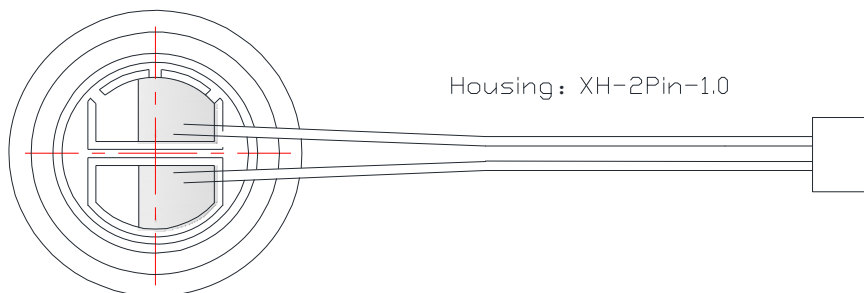
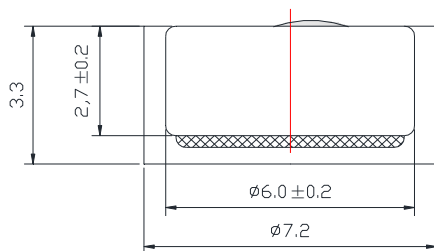
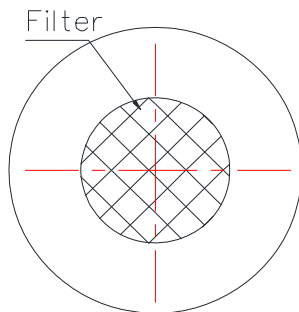

FIRST ANGLE PROJECTION

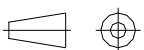

UNIT : mm

Tolerance : ±0.2