

Silicon NPN Power Transistors

... designed for medium-speed switching and amplifier applications. These devices feature:

- Total Switching Time at 3 A typically 1.15 μ s
- Gain Ranges Specified at 1 A and 3 A
- Low $V_{CE(sat)}$: typically 0.5 V at $I_C = 5$ A and $I_B = 0.5$ A
- Excellent Safe Operating Areas
- Complement to 2N3791-92

NPN
2N3715
2N3716

10 AMPERE
POWER TRANSISTORS
SILICON NPN
60-80 VOLTS
150 WATTS

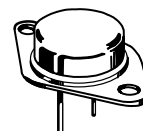

CASE 1-07
TO-204AA
(TO-3)

MAXIMUM RATINGS

Rating	Symbol	2N3715	2N3716	Unit
Collector-Emitter Voltage	V_{CEO}	60	80	Volts
Collector-Base Voltage	V_{CB}	80	100	Volts
Emitter-Base Voltage	V_{EB}	7.0	7.0	Volts
Collector Current	I_C	10	10	Amps
Base Current	I_B	4.0	4.0	Amps
Power Dissipation	P_D	150	150	Watts
Thermal Resistance	θ_{JC}	1.17	1.17	$^{\circ}\text{C}/\text{W}$
Operating Junction and Storage Temperature Range	T_J, T_{stg}	-65 to +200		$^{\circ}\text{C}$

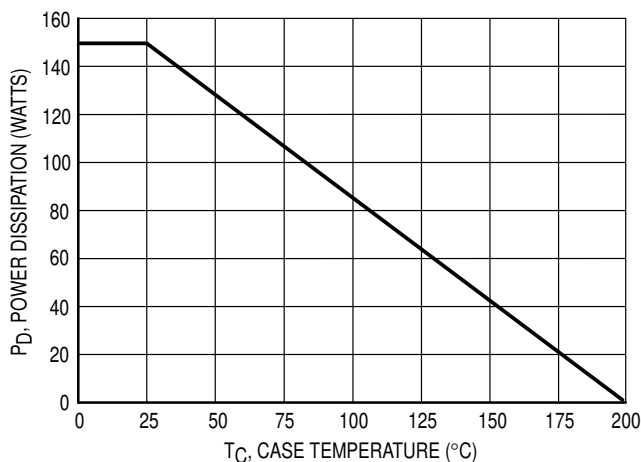

Figure 1. Power-Temperature Derating Curve

Safe Area Limits are indicated by Figures 12, 13. Both limits are applicable and must be observed.

REV 7

ELECTRICAL CHARACTERISTICS ($T_C = 25^\circ\text{C}$ unless otherwise noted)

Characteristic	Symbol	Min	Max	Unit
Emitter-Base Cutoff Current ($V_{EB} = 7.0\text{ Vdc}$)	I_{EBO}	—	5.0	mAdc
Collector-Emitter Cutoff Current ($V_{CE} = 80\text{ Vdc}, V_{BE} = -1.5\text{ Vdc}$) ($V_{CE} = 100\text{ Vdc}, V_{BE} = -1.5\text{ Vdc}$) ($V_{CE} = 60\text{ Vdc}, V_{BE} = -1.5\text{ Vdc}, T_C = 150^\circ\text{C}$) ($V_{CE} = 80\text{ Vdc}, V_{BE} = -1.5\text{ Vdc}, T_C = 150^\circ\text{C}$)	I_{CEX}	—	1.0 1.0 10 10	mAdc
Collector-Emitter Sustaining Voltage (1) ($I_C = 200\text{ mAdc}, I_B = 0$)	$V_{CEO(sus)}^*$	60 80	— —	Vdc
DC Current Gain (1) ($I_C = 1.0\text{ Adc}, V_{CE} = 2.0\text{ Vdc}$) ($I_C = 3.0\text{ Adc}, V_{CE} = 2.0\text{ Vdc}$)	h_{FE}^*	50 30	150 —	—
Collector-Emitter Saturation Voltage (1) ($I_C = 5.0\text{ Adc}, I_B = 0.5\text{ Adc}$)	$V_{CE(sat)}^*$	—	0.8	Vdc
Base-Emitter Saturation Voltage (1) ($I_C = 5.0\text{ Adc}, I_B = 0.5\text{ Adc}$)	$V_{BE(sat)}^*$	—	1.5	Vdc
Base-Emitter Voltage (1) ($I_C = 3.0\text{ Adc}, V_{CE} = 2.0\text{ Vdc}$)	V_{BE}^*	—	1.5	Vdc
Small Signal Current Gain ($V_{CE} = 10\text{ Vdc}, I_C = 0.5\text{ Adc}, f = 1.0\text{ MHz}$)	h_{fe}	4.0	—	—
Switching Times (Figure 2) ($I_C = 5.0\text{ A}, I_{B1} = I_{B2} = 0.5\text{ Adc}$) Rise Time Storage Time Fall Time		Typ		μs
	t_r	0.45		
	t_s	0.3		
	t_f	0.4		

(1) Pulse Test: Pulse Width $\leq 300\ \mu\text{s}$, Duty Cycle $\leq 2.0\%$.

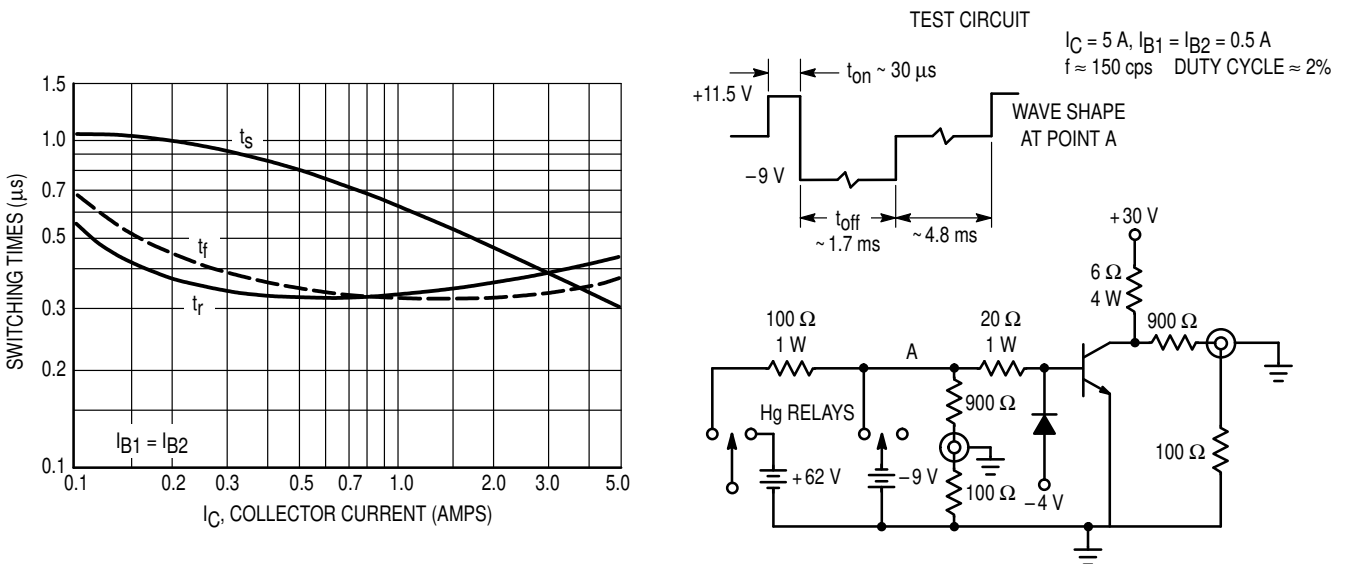

2N3715 2N3716

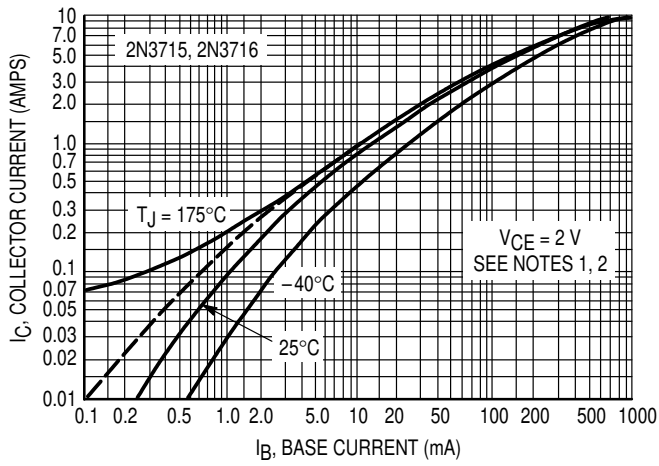

Figure 3. Collector Current versus Base Current

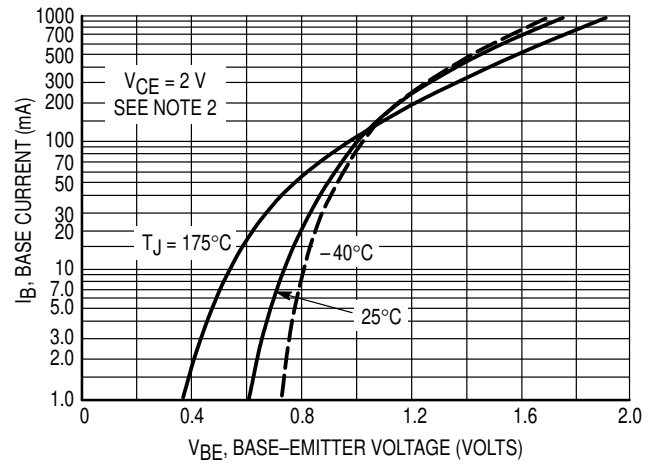

Figure 4. Base Current-Voltage Variations

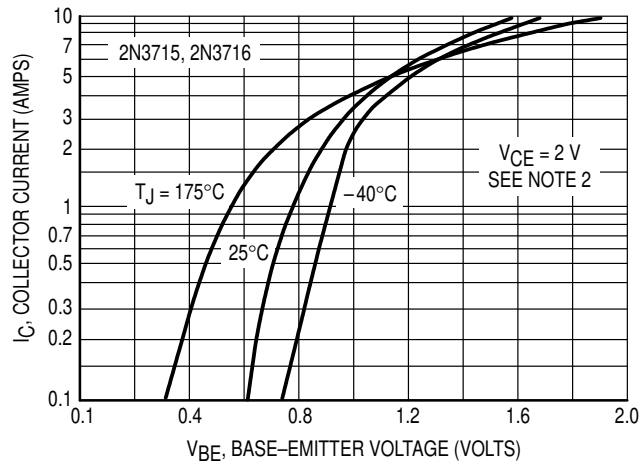

Figure 5. Collector Current-Voltage Variations

NOTE 1. Dotted line indicates metered base current plus the I_{CBO} of the transistor at 175°C .

NOTE 2. Pulse test: pulse width $\approx 200\ \mu\text{sec}$, duty cycle $\approx 1.5\%$.

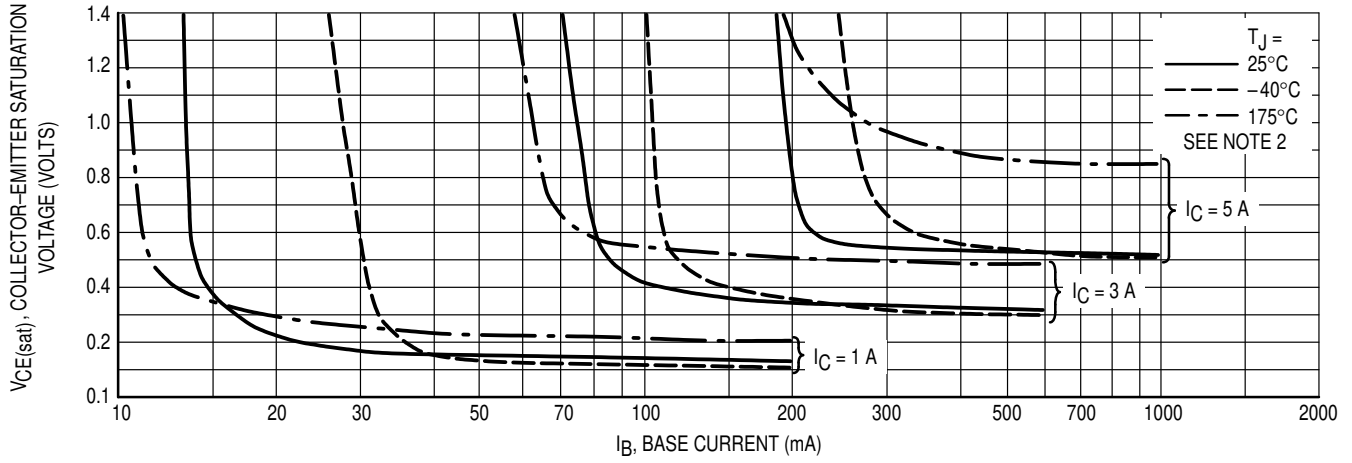

Figure 6. Collector-Emitter Saturation Voltage Variations

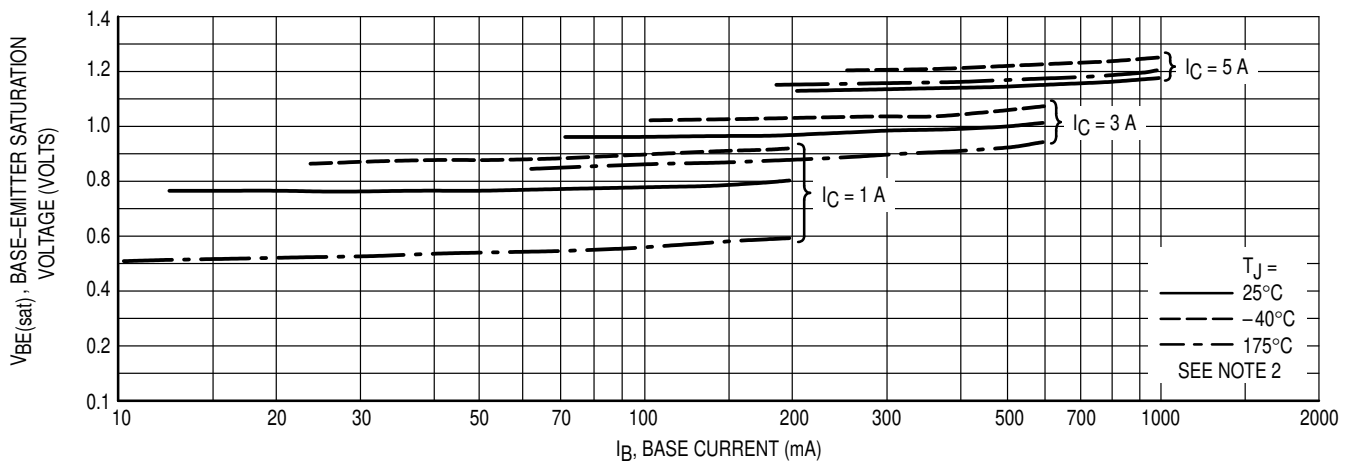

Figure 7. Base-Emitter Saturation Voltage Variations

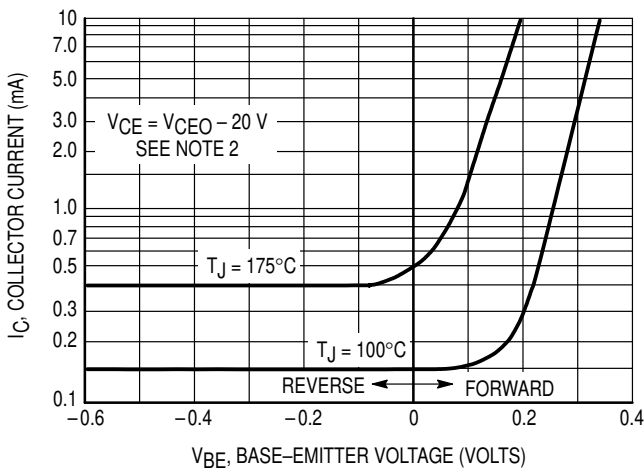

Figure 8. Collector Current versus Base-Emitter Voltage

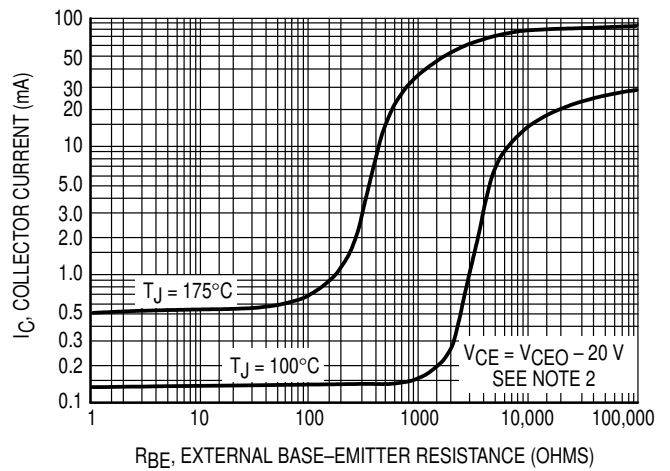

Figure 9. Collector Current versus Base-Emitter Resistance

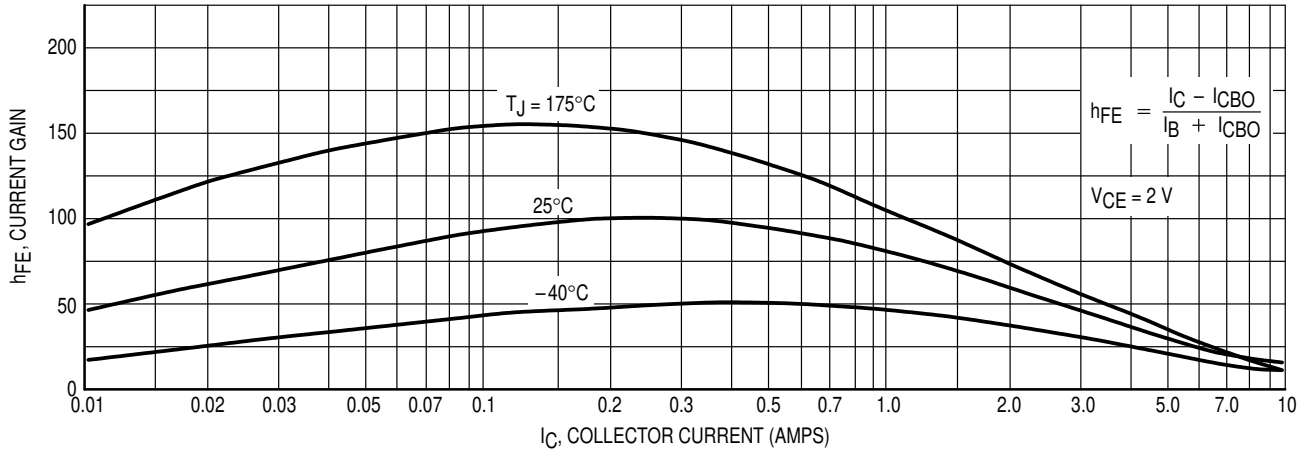

Figure 10. Current Gain Variations

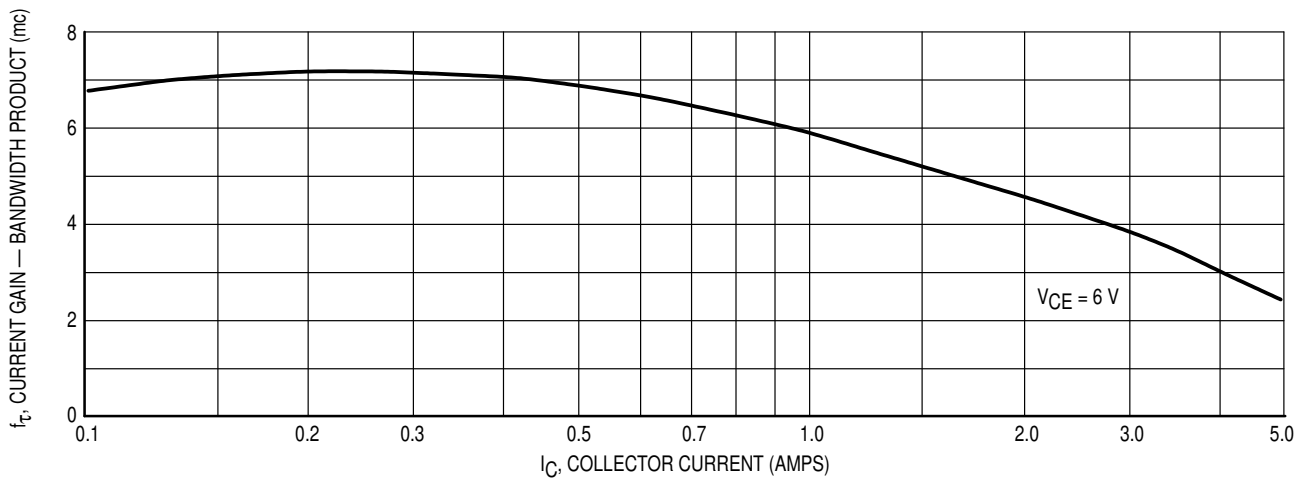

Figure 11. Current Gain — Bandwidth Product versus Collector Current

SAFE OPERATING AREAS

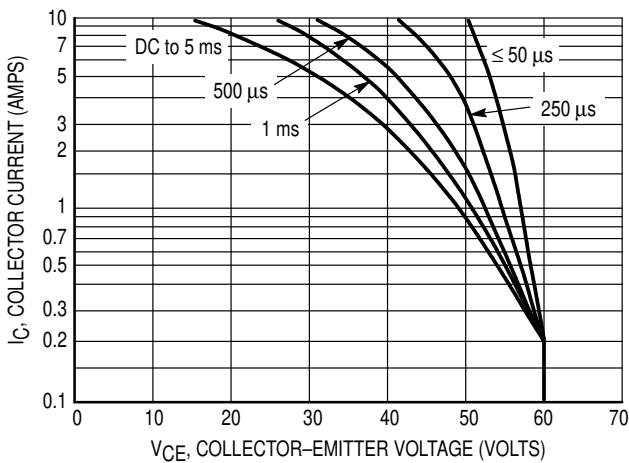

Figure 12. 2N3715

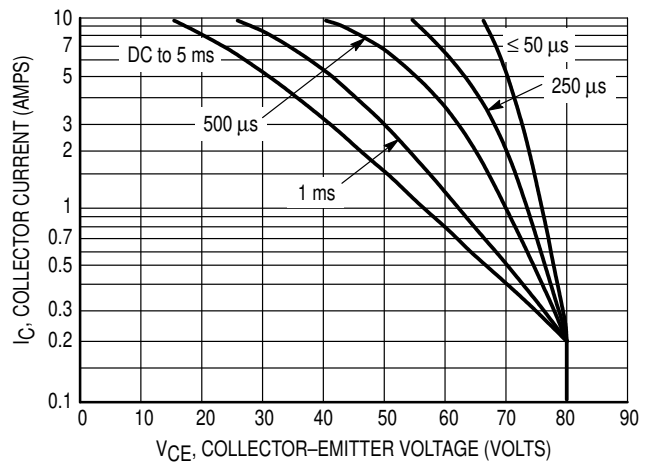
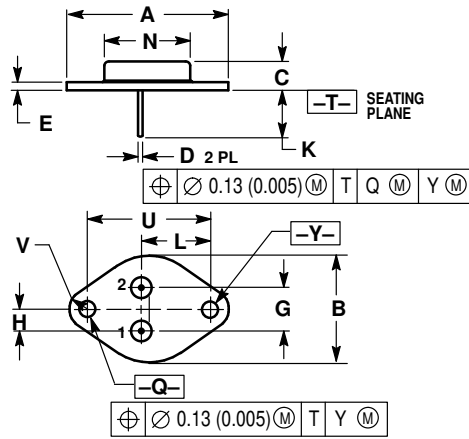

Figure 13. 2N3716

The Safe Operating Area Curves indicate $I_C - V_{CE}$ limits below which the device will not go into secondary breakdown. Collector load lines for specific circuits must fall within the applicable Safe Area to avoid causing a collector-emitter

short. (Duty cycle of the excursions make no significant change in these safe areas.) To insure operation below the maximum T_J , the power-temperature derating curve must be observed for both steady state and pulse power conditions.

PACKAGE DIMENSIONS



- NOTES:
1. DIMENSIONING AND TOLERANCING PER ANSI Y14.5M, 1982.
 2. CONTROLLING DIMENSION: INCH.
 3. ALL RULES AND NOTES ASSOCIATED WITH REFERENCED TO-204AA OUTLINE SHALL APPLY.

DIM	INCHES		MILLIMETERS	
	MIN	MAX	MIN	MAX
A	1.550 REF		39.37 REF	
B	—	1.050	—	26.67
C	0.250	0.335	6.35	8.51
D	0.038	0.043	0.97	1.09
E	0.055	0.070	1.40	1.77
G	0.430 BSC		10.92 BSC	
H	0.215 BSC		5.46 BSC	
K	0.440	0.480	11.18	12.19
L	0.665 BSC		16.89 BSC	
N	—	0.830	—	21.08
Q	0.151	0.165	3.84	4.19
U	1.187 BSC		30.15 BSC	
V	0.131	0.188	3.33	4.77

STYLE 1:
 PIN 1. BASE
 2. EMITTER
 CASE: COLLECTOR

CASE 1-07
 TO-204AA (TO-3)
 ISSUE Z

Motorola reserves the right to make changes without further notice to any products herein. Motorola makes no warranty, representation or guarantee regarding the suitability of its products for any particular purpose, nor does Motorola assume any liability arising out of the application or use of any product or circuit, and specifically disclaims any and all liability, including without limitation consequential or incidental damages. "Typical" parameters can and do vary in different applications. All operating parameters, including "Typicals" must be validated for each customer application by customer's technical experts. Motorola does not convey any license under its patent rights nor the rights of others. Motorola products are not designed, intended, or authorized for use as components in systems intended for surgical implant into the body, or other applications intended to support or sustain life, or for any other application in which the failure of the Motorola product could create a situation where personal injury or death may occur. Should Buyer purchase or use Motorola products for any such unintended or unauthorized application, Buyer shall indemnify and hold Motorola and its officers, employees, subsidiaries, affiliates, and distributors harmless against all claims, costs, damages, and expenses, and reasonable attorney fees arising out of, directly or indirectly, any claim of personal injury or death associated with such unintended or unauthorized use, even if such claim alleges that Motorola was negligent regarding the design or manufacture of the part. Motorola and are registered trademarks of Motorola, Inc. Motorola, Inc. is an Equal Opportunity/Affirmative Action Employer.

How to reach us:
 USA / EUROPE: Motorola Literature Distribution;
 P.O. Box 20912; Phoenix, Arizona 85036. 1-800-441-2447

JAPAN: Nippon Motorola Ltd.; Tatsumi-SPD-JLDC, Toshikatsu Otsuki,
 6F Seibu-Butsuryu-Center, 3-14-2 Tatsumi Koto-Ku, Tokyo 135, Japan. 03-3521-8315

MFAX: RMFAX0@email.sps.mot.com - TOUCHTONE (602) 244-6609
 INTERNET: <http://Design-NET.com>

HONG KONG: Motorola Semiconductors H.K. Ltd.; 8B Tai Ping Industrial Park,
 51 Ting Kok Road, Tai Po, N.T., Hong Kong. 852-26629298

