

## SR520-G Thru. SR5200-G

**Forward current: 5.0A**  
**Reverse voltage: 20 to 200V**  
**RoHS Device**

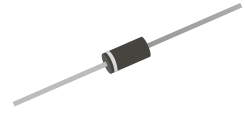

### Features

- Axial lead type devices for through hole design.
- Low power loss, high efficiency.
- High current capability, Low forward voltage drop.
- High surge capability.
- Guardring for overvoltage protection.
- Ultra high-speed switching.
- Silicon epitaxial planar chip, metal silicon junction.
- Lead-free part meets environmental standards of MIL-STD-19500/228

### Mechanical Data

- Case: Molded plastic, DO-201AD/DO-27
- Epoxy: UL94V-0 rate flame retardant.
- Lead: Axial lead, solderable per MIL-STD-202, Method 208 guaranteed.
- Polarity: color band denoted cathode end.
- Weight: 1.10 gram (approx.).

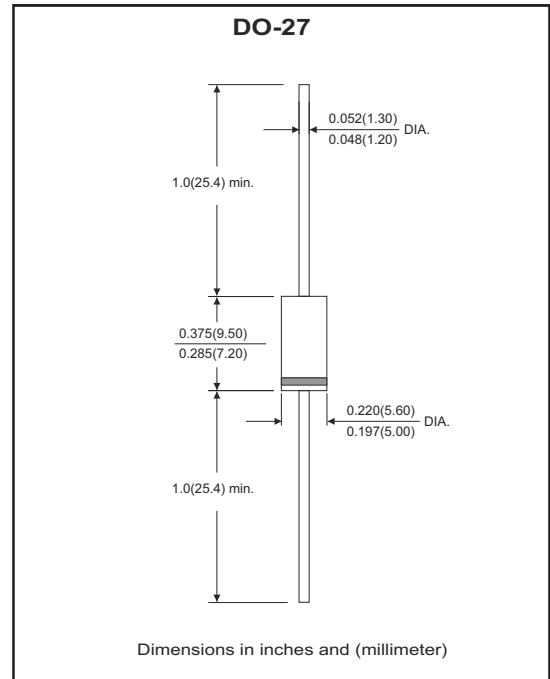

### Maximum Ratings and Electrical Characteristics

Ratings at  $T_a=25^{\circ}\text{C}$  unless otherwise noted.  
 Single phase, half wave, 60Hz, resistive or inductive loaded.  
 For capacitive load, derate current by 20% .

Parameter	Symbol	SR520 -G	SR540 -G	SR560 -G	SR5100 -G	SR5150 -G	SR5200 -G	Unit
Maximum recurrent peak reverse voltage	$V_{RRM}$	20	40	60	100	150	200	V
Maximum RMS voltage	$V_{RMS}$	14	28	42	70	105	140	V
Maximum DC blocking voltage	$V_{DC}$	20	40	60	100	150	200	V
Maximum instantaneous forward voltage at $I_F=5A, T_A=25^{\circ}\text{C}$	$V_F$	0.50	0.55	0.75	0.81	0.87	0.90	V
Operating junction temperature range	$T_J$	-50 ~ +150				-50 ~ +175		$^{\circ}\text{C}$

Parameter	Conditions	Symbol	MIN.	TYP.	MAX.	Unit
Forward rectified current	see Fig.1	$I_o$			5.0	A
Forward surge current	8.3ms single half sine-wave superimposed on rate load (JEDEC method)	$I_{FSM}$			125	A
Reverse Current	$V_R = V_{RRM} T_A=25^{\circ}\text{C}$	$I_R$			0.5	mA
	$V_R = V_{RRM} T_A=100^{\circ}\text{C}$	$I_R$			20	mA
Thermal Resistance	Junction to ambient	$R_{\theta JA}$		24		$^{\circ}\text{C/W}$
Diode Junction capacitance	$f=1\text{MHz}$ and applied 4V DC reverse Voltage	$C_J$		380		pF
Storage temperature		$T_{STG}$	-50		+175	$^{\circ}\text{C}$

## RATING AND CHARACTERISTIC CURVES (SR520-G Thru. SR5200-G)

Fig.1 - Typical Forward Current Derating Curve

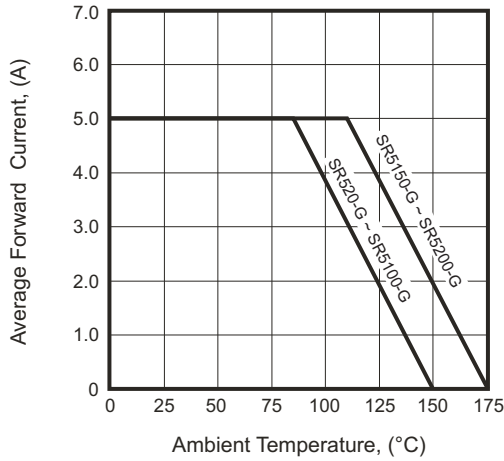

Fig.2 - Typical Forward Characteristics

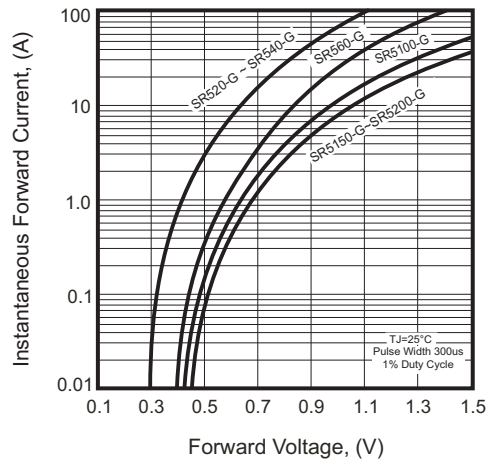

Fig.3 - Maximum Non-repetitive Forward Surge Current

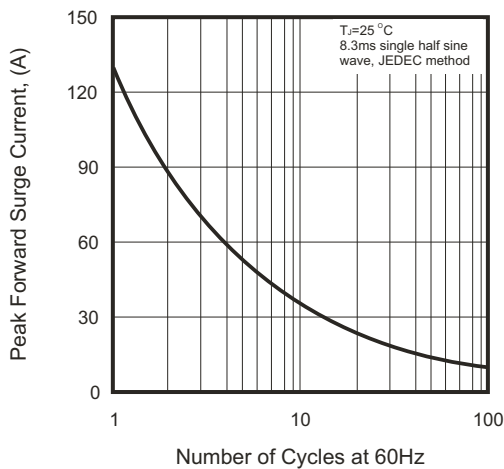

Fig.4 - Typical Junction Capacitance

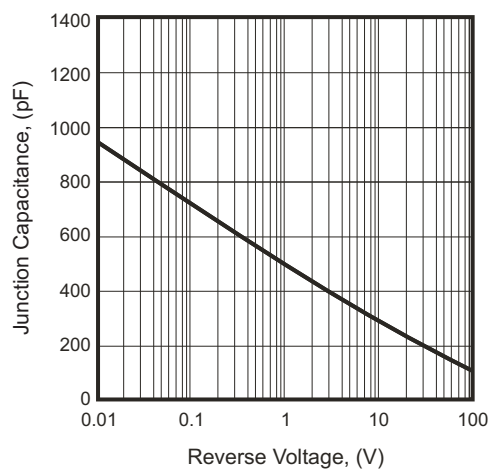
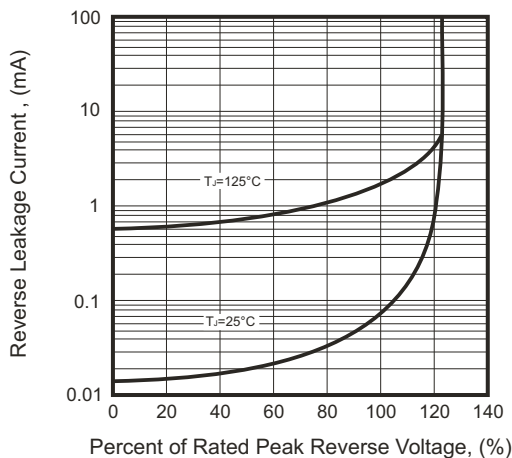
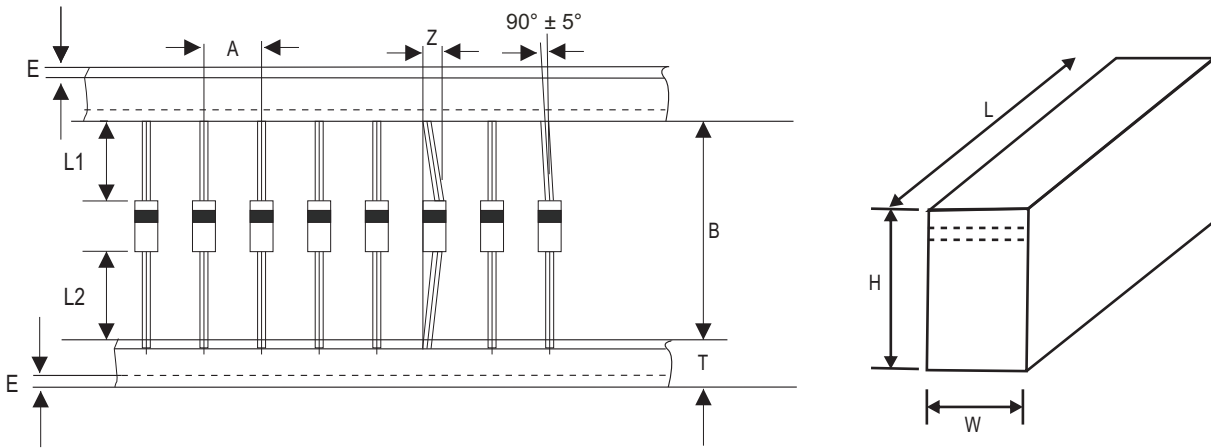

Fig.5 - Typical Reverse Characteristics



## Taping Specification For Axial Lead Diodes



DO-27	SYMBOL	A	B	Z	T	E	L1	L2
	(mm)	9.30 ± 0.50	52.40 (max)	1.20 (max)	6.00 ± 0.40	0.80 (max)	1.00 (max)	1.00 (max)
	(inch)	0.366 ± 0.020	2.063 (max)	0.047 (max)	0.236 ± 0.016	0.031 (max)	0.039 (max)	0.039 (max)

DO-27	SYMBOL	D1	D0	D	W0	L	W	H
	(mm)	85.70 ± 0.30	16.60 ± 0.40	330.00	72.00 ± 3.00	260.00	75.00	145.00
	(inch)	3.374 ± 0.012	0.654 ± 0.016	13.000	2.835 ± 0.118	10.236	2.953	5.709

## Marking Code

Part Number	Marking Code
SR520-G	SR52
SR540-G	SR54
SR560-G	SR56
SR5100-G	SR510
SR5150-G	SR515
SR5200-G	SR520

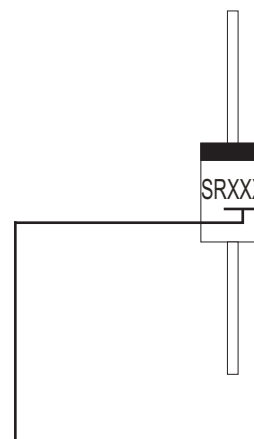

XX / XXX = Product type marking code

## Standard Packaging

Case Type	AMMO PACK	
	BOX ( pcs )	CARTON ( pcs )
DO-27	500	9,000

This datasheet has been downloaded from:

[www.DatasheetCatalog.com](http://www.DatasheetCatalog.com)

Datasheets for electronic components.