

MITSUBISHI ICs (TV)  
**M52016SP**

**PAL/NTSC VIDEO CHROMA DEFLECTION**

**DESCRIPTION**

The M52016SP is a semiconductor integrated circuit for video, chroma, and deflection signal processing. Combined with IC component M51346AP for VIF/SIF, it realizes practical color television using only two IC components.

Circuit configuration includes built-in sync separation, horizontal AFC, horizontal oscillator, horizontal count-down, vertical count-down, contrast control, luminance control, picture quality control, ACC/killer detector, ident detector, APC detector, chroma oscillator, NTSC tint control, and chroma demodulator functions.

The M52016SP is packaged as a 32-pin, bipolar monolithic, formed plastic shrink DIP.

**FEATURES**

- Large-scale, single-chip construction enhances practicality and reliability of the television set itself while contributing to lower power consumption.
- Places of adjustment and number of external components are minimized.
- NTSC system switch enables construction of a PAL/NTSC system with a minimal amount of peripheral components. (Switches, demodulator axis, demodulation ratio, PAL matrix, and tint control.)
- Employs a sync detector system for ACC/killer detector; realizes superior weak electric field killer level.
- Double AFC in the horizontal circuit effectively reduces weak electric field horizontal "jitter," and "bending" on the screen is minimized thanks to luminance alteration. VCR switch improves skew distortion. Sync sensor circuit

**PIN CONFIGURATION (TOP VIEW)**

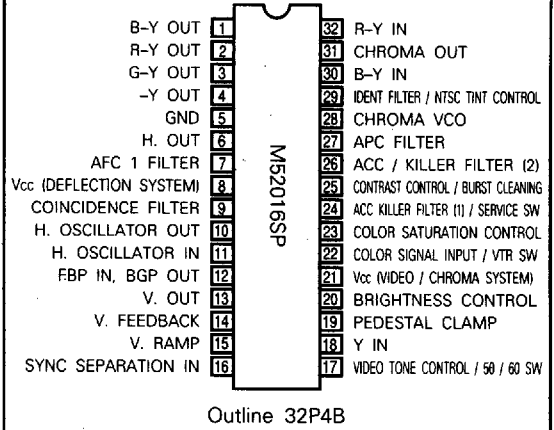

not only expands pull-in range, but can be used as a sensor signal for sound muting, automatic channel selection, etc.

- Contains built-in service switch. (Contrast minimum killer on, vertical output off)

**APPLICATION**

PAL/NTSC System Color Television Receiver

**RECOMMENDED OPERATING CONDITION**

Supply voltage range ..... 10~13V  
 Rated supply voltage ..... 11V

**BLOCK DIAGRAM**

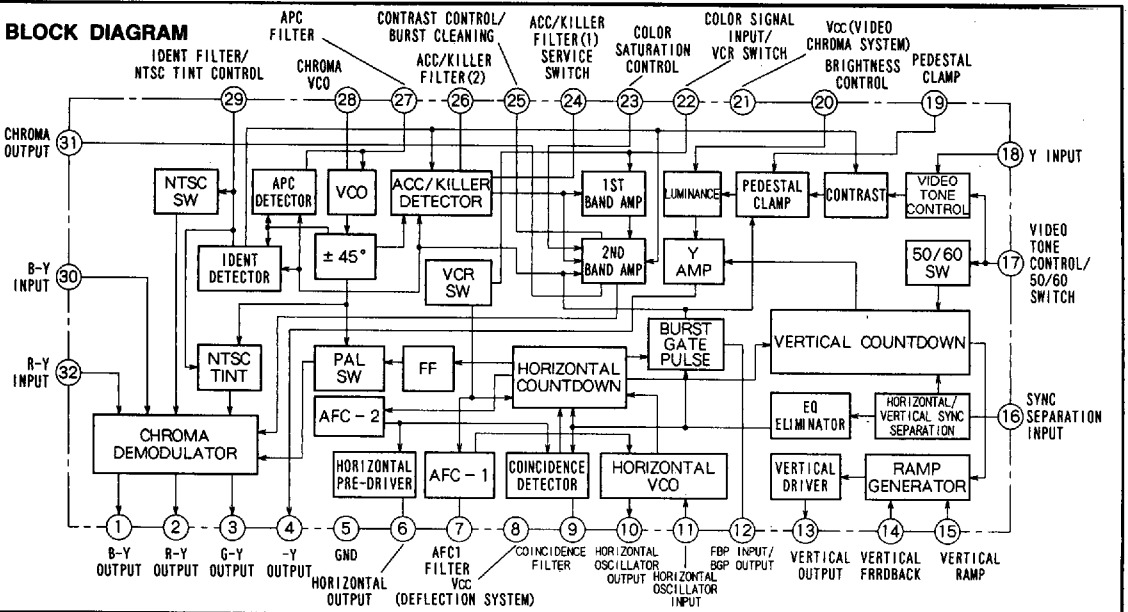

M52016SP

PAL/NTSC VIDEO CHROMA DEFLECTION

ABSOLUTE MAXIMUM RATINGS

Symbol	Parameter	Ratings	Unit
V <sub>cc</sub>	Supply voltage	13.5	V
P <sub>d</sub>	Power Dissipation	1.25	W
Surge	Surge voltage resistance	± 200	V
V <sub>i4</sub>	Pin ④ voltage	0.28V <sub>cc</sub> + 6	V
I <sub>i5</sub>	Pin ⑤ input current	+ 6	mA
I <sub>i2</sub>	Pin ⑫ input current	- 1.0	mA
T <sub>opr</sub>	Operating temperature	- 20~65	°C
T <sub>stg</sub>	Storage temperature	- 40~125	°C

Note. The normal direction for current flow is the direction when output from the IC component. Use the absolute value as standard value.

ELECTRICAL CHARACTERISTICS (T<sub>a</sub> = 25°C, unless otherwise noted)

VIDEO SECTION/CHROMA SECTION

Symbol	Parameter	Test	Input C	Test conditions*													Limits			Unit
				17A	19	20A	23A	25A	29A	S <sub>24-1</sub>	S <sub>24-2</sub>	S <sub>26</sub>	S <sub>29</sub>	S <sub>32</sub>	S <sub>20</sub>	12A	Note	Min.	Typ.	
I <sub>cc</sub> - Y <sub>c</sub>	Circuit current	A.1	-	-	-	-	-	-	ON	OFF	OFF	OFF	1	OFF	V <sub>cc</sub>	Note1	32	45	58	mA
Y <sub>max</sub>	Maximum output	4	SG1	-	-	-	-	V <sub>cc</sub>	ON	OFF	OFF	OFF	1	OFF	V <sub>cc</sub>	Note1	7.0	8.0		V <sub>P-P</sub>
GY	Video amp gain	4	SG2	-	2V	-	-	V <sub>cc</sub>	ON	OFF	OFF	OFF	1	OFF	V <sub>cc</sub>	Note2	18	21	24	dB
GY <sub>mid-1</sub>	Contrast control characteristics - 1	4	SG2	-	2V	-	-	5.5V	ON	OFF	OFF	OFF	1	OFF	V <sub>cc</sub>	Note3	0.65	0.95	1.25	V <sub>P-P</sub>
GY <sub>max</sub>																	5.3	7.3	9.3	dB
GY <sub>min</sub>	Contrast control characteristics-2	4	SG2	-	2V	-	-	0V	ON	OFF	OFF	OFF	1	OFF	V <sub>cc</sub>	Note4		-39	-32	dB
GY <sub>mid-2</sub>	Contrast control characteristics-3	4	SG2	-	2V	-	-	5V	ON	OFF	OFF	OFF	1	OFF	V <sub>cc</sub>	Note5	-8	-6	-4	dB
YT <sub>mid</sub>	Video tone control characteristics-1	4	SG3	5.5V	2V	-	-	5.5V	ON	OFF	OFF	OFF	1	OFF	V <sub>cc</sub>	Note6	0.9	1.35	2.0	V <sub>P-P</sub>
YT <sub>min</sub>	Video tone control characteristics-2	4	SG3	V <sub>cc</sub>	2V	-	-	5.5V	ON	OFF	OFF	OFF	1	OFF	V <sub>cc</sub>	Note7	-11	-8	-5	dB
YT <sub>max</sub>	Video tone control characteristics-3	4	SG3	1.5V	2V	-	-	5.5V	ON	OFF	OFF	OFF	1	OFF	V <sub>cc</sub>	Note8	2.0	4.6	7.0	dB
YP	Peaking value	4	C SG2 SG3	-	2V	-	-	5.5V	ON	OFF	OFF	OFF	1	OFF	V <sub>cc</sub>	Note9	1.0	3.0	5.0	dB
Y <sub>BRTmid</sub>	Brightness control characteristics-1	4	-	-	-	5.5V	-	5.5V	ON	OFF	OFF	OFF	1	OFF	V <sub>cc</sub>	Note10	4.55	5.15	5.75	V
Y <sub>BRTmin</sub>	Brightness control characteristics-2	4	-	-	-	V <sub>cc</sub>	-	5.5V	ON	OFF	OFF	OFF	1	OFF	V <sub>cc</sub>	Note11	2.7	3.3	3.9	V
Y <sub>BRTmax</sub>	Brightness control characteristics-3	4	-	-	-	0V	-	5.5V	ON	OFF	OFF	OFF	1	OFF	V <sub>cc</sub>	Note12	6.4	7.0	7.6	V
Y <sub>f</sub>	Frequency characteristics	4	C SG2 SG4	-	2V	-	-	5.5V	ON	OFF	OFF	OFF	1	OFF	V <sub>cc</sub>	Note13	-3.0	1.0	5.0	dB
DG	Differential gain	4	C SG2	-	2.4V 1.8V	-	-	5.5V	ON	OFF	OFF	OFF	1	OFF	V <sub>cc</sub>	Note14			10	%
H.BLKTH	Horizontal blanking threshold voltage	4	D 1A SG5	-	2V	-	-	5.5V	ON	OFF	OFF	OFF	1	OFF	V <sub>cc</sub>	Note15	9.0	9.5	10.0	V
Y <sub>V</sub> .BLK	Vertical blanking voltage	4	-	-	-	-	-	5.5V	ON	OFF	OFF	OFF	1	OFF	V <sub>cc</sub>	Note16	8.2	8.8	9.4	V
Y <sub>DC</sub> .REG	DC playback ratio control characteristics	4	C SGa	-	-	5.5V	-	5.5V	ON	OFF	OFF	OFF	1	ON ↓ OFF	V <sub>cc</sub>	Note17	0.9	1.5	2.1	V
ΔY <sub>DC</sub> /T <sub>a</sub>	Video DC level temperature characteristics	4	-	-	-	5.5V	-	5.5V	ON	OFF	OFF	OFF	1	OFF	V <sub>cc</sub>	Note18	2.0	4.0	6.0	mV/°C
C <sub>max</sub>	Maximum output	31	SG5 0dB	-	-	-	-	V <sub>cc</sub> V <sub>cc</sub>	ON	OFF	OFF	OFF	1	OFF	V <sub>cc</sub>		2.4	3.0	3.6	V <sub>P-P</sub>
GC	Chroma maximum gain	31	SG5 Variable	-	-	-	-	V <sub>cc</sub> V <sub>cc</sub>	ON	OFF	OFF	OFF	1	OFF	V <sub>cc</sub>	Note19	42	48	54	dB
Acc1	ACC characteristics - 1	31	SG5 0dB -20dB	-	-	-	-	5.5V	ON	OFF	OFF	OFF	1	OFF	V <sub>cc</sub>	Note20	-3.0	-1.0	1.0	dB
Acc2	ACC characteristics - 2	31	SG5 +6dB	-	-	-	-	5.5V	ON	OFF	OFF	OFF	1	OFF	V <sub>cc</sub>	Note21	-2.6	0.4	2.4	dB
KIL	Killer operation input	SG5 23	SG5	-	-	-	-	5.5V	ON	OFF	OFF	OFF	1	OFF	V <sub>cc</sub>	Note22	-31	-25	-20	dB
D.KIL	Killer color residual	31	SG5 0dB	-	-	-	-	5.5V	ON	OFF	OFF	OFF	1	OFF	V <sub>cc</sub>	Note23			200	mV <sub>P-P</sub>

\* : "-" indicates OPEN.



M52016SP

PAL/NTSC VIDEO CHROMA DEFLECTION

VIDEO/CHROMA SECTION (cont.)

Symbol	Parameter	Test point	Input C	Test conditions*													Limits			Unit		
				17A	19	20A	23A	25A	29A	S24-1	S24-2	S26	S29	S32	S20	12A	Note	Min.	Typ.		Max.	
CC <sub>mid-1</sub>	Color control characteristics - 1	31	SG5 0dB	-	-	-	5.5V	V <sub>CC</sub>	-	ON	OFF	OFF	OFF	OFF	1	OFF	V <sub>CC</sub>	Note 24	0.7	1.2	1.7	V <sub>P-P</sub>
CC <sub>max</sub>																			4.0	8.0	12.0	dB
CC <sub>min</sub>	Color control characteristics - 2	31	SG5 0dB	-	-	-	0V	V <sub>CC</sub>	-	ON	OFF	OFF	OFF	OFF	1	OFF	V <sub>CC</sub>	Note 25		-40	-30	dB
CC <sub>mid-2</sub>	Color control characteristics - 3	31	SG5 0dB	-	-	-	5V	V <sub>CC</sub>	-	ON	OFF	OFF	OFF	OFF	1	OFF	V <sub>CC</sub>	Note 26	-5.0	-3.3	-1.3	dB
APC1	APC pull-in range - 1	23 SG6	D SG6	-	-	-	5.5V	-	ON	OFF	OFF	OFF	OFF	1	OFF	V <sub>CC</sub>	Note 27	580	900		Hz	
APC2	APC pull-in range - 2	23 SG6	D SG6	-	-	-	5.5V	-	ON	OFF	OFF	OFF	OFF	1	OFF	V <sub>CC</sub>	Note 28	850	1500		Hz	
D <sub>dc</sub>	Demodulated output DC voltage	1A 2A 3A	-	-	-	-	5.5V	-	ON	OFF	OFF	OFF	OFF	1	OFF	V <sub>CC</sub>	Note 29	5.9	6.4	6.9	V	
D <sub>offset</sub>	Demodulated output DC offset	-	-	-	-	-	-	-	-	-	-	-	-	-	-	-	Note 30				0.3	V
D <sub>max</sub>	Demodulated output maximum amplitude	1A	E SG7 0.5 V <sub>P-P</sub>	-	-	-	-	-	OFF	OFF	OFF	OFF	OFF	2	OFF	V <sub>CC</sub>		3.5	4.5	5.5	V <sub>P-P</sub>	
D <sub>B-Y</sub>	B-Y modulated sensitivity	1A	E SG7 0.2 V <sub>P-P</sub>	-	-	-	5.5V	-	OFF	OFF	OFF	OFF	OFF	2	OFF	V <sub>CC</sub>		2.4	2.9	3.4	V <sub>P-P</sub>	
R/B	Demodulated ratio - 1	2A	E SG7 0.2 V <sub>P-P</sub>	-	-	-	5.5V	-	OFF	OFF	OFF	OFF	OFF	2	OFF	V <sub>CC</sub>	Note 31	0.56	0.63	0.70	-	
G/B	Demodulated ratio - 2	3A	E SG7 0.2 V <sub>P-P</sub>	-	-	-	5.5V	-	OFF	OFF	OFF	OFF	OFF	2	OFF	V <sub>CC</sub>	Note 32	0.31	0.37	0.43	-	
Δ D/H	Demodulated output 1H level difference	2A	E SG7 0.2 V <sub>P-P</sub>	-	-	-	0V	5.5V	-	OFF	OFF	OFF	OFF	2	OFF	V <sub>CC</sub>	Note 33				35	mV <sub>P-P</sub>
C <sub>leak</sub>	Demodulated output carrier leak	1A 2A 3A	-	-	-	-	5.5V	-	ON	OFF	OFF	OFF	OFF	1	OFF	V <sub>CC</sub>	Note 34				0.2	V <sub>P-P</sub>
V <sub>23</sub>	Pin @ voltage (killer ON)	23	-	-	-	-	5.5V	-	ON	OFF	ON	OFF	OFF	1	OFF	V <sub>CC</sub>			0.12	0.5	V	
V <sub>NTSC</sub>	NTSC operation control voltage	1A 29A	E SG7 0.2 V <sub>P-P</sub>	-	-	-	5.5V	Variable	OFF	OFF	OFF	OFF	ON	2	OFF	V <sub>CC</sub>	Note 35	4.53	4.7	5.05	V	
NTSC B	Demodulated output (NTSC)	1A	D SG9 0dB	-	-	-	5.5V	5.5V	2V	ON	OFF	OFF	ON	1	OFF	V <sub>CC</sub>		2.4	3.4	4.7	V <sub>P-P</sub>	
NTSC R/B	Demodulation ratio - 1 (NTSC)	2A	D SG9 0dB	-	-	-	5.5V	2V	ON	OFF	OFF	ON	1	OFF	V <sub>CC</sub>	Note 36	0.9	1.0	1.1	-		
NTSC G/B	Demodulation ratio - 2 (NTSC)	3A	D SG9 0dB	-	-	-	5.5V	2V	ON	OFF	OFF	ON	1	OFF	V <sub>CC</sub>	Note 37	0.23	0.28	0.33	-		
V <sub>P/N</sub>	PAL/NTSC demodulated output DC voltage	1A	-	-	-	-	5.5V	2V	ON	OFF	OFF	ON	OFF	1	OFF	V <sub>CC</sub>	Note 38				300	mV
Δ D/KIL	Killer ON/OFF demodulated output DC voltage difference	1A	-	-	-	-	5.5V	-	OFF	OFF	ON	OFF	OFF	1	OFF	V <sub>CC</sub>	Note 39				50	mV
SS	Service switch operation	4 13 23	C SG2	-	-	-	5.5V	-	ON	ON	OFF	OFF	OFF	1	OFF	V <sub>CC</sub>	Note 40				-	
D <sub>bw</sub>	Demodulated output bandwidth	1 2 3	E SG8	-	-	-	5.5V	-	OFF	OFF	OFF	OFF	OFF	2	OFF	V <sub>CC</sub>	Note 41	0.7	0.9		MHz	
CD	Chroma input dynamic range	31	D SG5	-	-	-	5.5V	-	ON	OFF	OFF	OFF	OFF	1	OFF	V <sub>CC</sub>	Note 42	0.8	1.2		V <sub>P-P</sub>	
∠R-Y-P	PAL demodulated phase angle	1A	E SG8 4.53 MHz	-	-	-	5.5V	-	OFF	OFF	OFF	OFF	OFF	2	OFF	V <sub>CC</sub>	Note 43		90		deg.	
∠G-Y-P		2A 3A	-	-	-	-	5.5V	-	OFF	OFF	OFF	OFF	OFF	2	OFF	V <sub>CC</sub>			241		deg.	
∠R-Y-N	NTSC demodulated phase angle	1A	D	-	-	-	5.5V	2V	ON	OFF	OFF	ON	1	OFF	V <sub>CC</sub>	Note 44		100		deg.		
∠G-Y-N		2A 3A	SG9 0dB	-	-	-	5.5V	2V	ON	OFF	OFF	ON	1	OFF	V <sub>CC</sub>			232		deg.		
T <sub>min</sub>	NTSC TINT	1A	D	-	-	-	5.5V	Variable	ON	OFF	OFF	ON	1	OFF	V <sub>CC</sub>	Note 45	29	49	69	deg.		
T <sub>max</sub>		2A	SG6 0dB	-	-	-	5.5V	Variable	ON	OFF	OFF	ON	1	OFF	V <sub>CC</sub>		20	40	60	deg.		
D <sub>dc</sub> /T <sub>a</sub>	Demodulated output DC voltage temperature characteristics	1A 2A 3A	-	-	-	-	5.5V	-	ON	OFF	OFF	OFF	OFF	1	OFF	V <sub>CC</sub>	Note 46	-2	0	+2	mV/°C	

\*: "-" indicates OPEN.

M52016SP

PAL/NTSC VIDEO CHROMA DEFLECTION

DEFLECTION SECTION - 1

Symbol	Parameter	Test point	Input A	Test conditions*														Limits			Unit	
				9	12A	14	15A	Vcc	22A	S6	S14	S16	S17	S22	S24-2	S7	Note	Min.	Typ.	Max.		
Icc - D	Circuit current	A2	SGa	-	Vcc	6V	GND	11V	-	ON	OFF	1	OFF	OFF	OFF	ON		21	30	39	mA	
V8min	Horizontal oscillator starting voltage	6	-	-	Vcc	6V	GND	11V	Variable	-	ON	OFF	3	OFF	OFF	OFF	ON	Note 47		5.2	6.2	V
fH	Horizontal freerun frequency	6	-	-	Vcc	6V	GND	11V	-	ON	OFF	3	OFF	OFF	OFF	ON	Note 48	15.45	15.625	15.8	kHz	
fPH1L	Horizontal pull-in range-1	6	SGb	6V	Vcc	6V	GND	11V	-	ON	OFF	1	OFF	OFF	OFF	ON	Note 49		-970	-660		Hz
fPH1H																		+550	+900		Hz	
fPH2L																			-1100	-700		Hz
fPH2H	Horizontal pull-in range-2	6	SGb	6V	Vcc	6V	GND	11V	-	ON	OFF	1	OFF	ON	OFF	ON	Note 50	+650	+1000		Hz	
VCR SW	VCR SW threshold voltage	6 22	SGb	-	Vcc	6V	GND	11V	Variable	ON	OFF	1	OFF	OFF	OFF	ON	Note 51	4.6	5.1	5.6	V	
V9H	Coincidence detection maximum voltage	9	SGa	-	Vcc	6V	GND	11V	-	ON	OFF	1	OFF	OFF	OFF	ON		9.5	10.3		V	
V9L	Coincidence detection minimum voltage	9	-	-	Vcc	6V	GND	11V	-	ON	OFF	3	OFF	OFF	OFF	ON			0	0.5		V
τH	Horizontal output pulse amplitude	6	SGa	-	Vcc	6V	GND	11V	-	ON	OFF	1	OFF	OFF	OFF	ON	Note 52	22	24	26	μ sec	
VHmin	Horizontal output voltage	6	SGa	-	Vcc	6V	GND	11V	-	OFF	OFF	1	OFF	OFF	OFF	ON	Note 53	3.0	3.85	4.7		V
VHmax																			0.04	0.16		V
TGP	Burst gate pulse position	12	SGa	-	Vcc	6V	GND	11V	-	ON	OFF	1	OFF	OFF	OFF	ON	Note 54	3.5	4.3	5.3	μ sec	
fv50	Vertical freerun frequency 50(Hz)	13	-	-	Vcc	6V	GND	11V	-	ON	OFF	3	OFF	OFF	OFF	ON		43	44.4	46	Hz	
fv60	Vertical freerun frequency 60(Hz)	13	-	-	Vcc	6V	GND	11V	-	ON	OFF	3	ON	OFF	OFF	ON		50.5	52.8	55	Hz	
fpv50	Vertical pull-in range 50(Hz)	13	SGc	-	Vcc	6V	GND	11V	-	ON	OFF	1	OFF	OFF	OFF	ON	Note 55	54	55.7	58	Hz	
fpv60	Vertical pull-in range 60(Hz)	13	SGc	-	Vcc	6V	GND	11V	-	ON	OFF	1	ON	OFF	OFF	ON	Note 56	65	66.3	69	Hz	
τv50	Vertical output pulse amplitude 50 (Hz)	13	-	-	Vcc	6V	GND	11V	-	ON	OFF	3	OFF	OFF	OFF	ON	Note 57	474	544	614	μ sec	
τv60	Vertical output pulse amplitude 60 (Hz)	13	-	-	Vcc	6V	GND	11V	-	ON	OFF	3	ON	OFF	OFF	ON	Note 58	474	544	614	μ sec	
Vvmax	Vertical output maximum voltage	13	SGa	-	Vcc	6V	GND	11V	-	ON	OFF	1	OFF	OFF	OFF	ON	Note 59	3.2	4.2		Vo-P	

\*: "-" indicates OPEN.

DEFLECTION SECTION - 2

Symbol	Parameter	Test point	Input A	Test conditions*														Limits			Unit	
				9	12A	14	15A	Vcc	22A	S6	S14	S16	S17	S22	S24-2	S7	S15	Note	Min.	Typ.		Max.
Vvmin	Vertical output minimum voltage	13	SGa	-	Vcc	6V	GND	11V	-	ON	OFF	1	OFF	OFF	OFF	ON	OFF	Note 60			0.3	V
Pramp	Ramp peak voltage	15	SGa	-	Vcc	6V	-	11V	-	ON	OFF	1	OFF	OFF	OFF	ON	ON	Note 61	6.4	6.8	7.2	V
Vramp	Ramp amplitude	15	SGa	-	Vcc	6V	-	11V	-	ON	OFF	1	OFF	OFF	OFF	ON	ON	Note 62	1.5	1.8	2.1	Vp-P
GvV	Vertical open loop gain	13	B SGd -30dB	-	Vcc	14A 5V	GND	11V	-	ON	ON	3	OFF	OFF	ON	ON	OFF	Note 63	16	20	24	dB
Iss	Sync separation input sensitivity current	12	-	-	Vcc	6V	GND	11V	-	ON	OFF	2	OFF	OFF	OFF	ON	OFF	Note 64	0.07	0.1	0.15	mA
TBGP1	Burst gate pulse timing - 1	12	SGa	-	Vcc	6V	GND	11V	-	ON	OFF	1	OFF	OFF	OFF	ON	OFF	Note 65	0.25	0.4	0.6	μ sec
TBGP2	Burst gate pulse timing - 2	12	SGa	-	Vcc	6V	GND	11V	-	ON	OFF	1	OFF	OFF	OFF	ON	OFF	Note 66	3.4	4.0	4.6	μ sec
VFBP	Flyback pulse clamp voltage	12	SGa	-	Vcc	6V	GND	11V	-	ON	OFF	1	OFF	OFF	OFF	ON	OFF	Note 67	4.5	5.0	5.5	V
VGBP	Burst gate pulse voltage	12	SGa	-	Vcc	6V	GND	11V	-	ON	OFF	1	OFF	OFF	OFF	ON	OFF	Note 68	9.5	10.0	10.5	V

\*: "-" indicates OPEN.

M52016SP

PAL/NTSC VIDEO CHROMA DEFLECTION

DEFLECTION SECTION - 3

Symbol	Parameter	Test point	Input	Test conditions*												Limits			Unit	
				9	12A	14	15A	Vcc	22A	S6	S14	S16	S17	S22	S24-2	Note	Min.	Typ.		Max.
AFC2 <sub>min</sub>	AFC interlocking range	6	-	-	-	6V	GND	11V	-	OFF	OFF	3	OFF	OFF	OFF	Note 69		1.0	4	μ sec
AFC2 <sub>max</sub>		12B	-	-	-	6V	GND	11V	-	OFF	OFF	3	OFF	OFF	OFF		12	20		
AFC2G	AFC - 2 loop gain	6 12B 12	-	-	-	6V	GND	11V	-	OFF	OFF	3	OFF	OFF	OFF	Note 70	31	41	51	dB

\* : "-" indicates OPEN.

VIDEO SECTION / CHROMA SECTION

Note1. Maximum Output "Y<sub>max</sub>"

a) Test amplitude when not V blanking. Wave form should be distorted at this time.

Note2. Video Amplifier Gain "GY"

a) Test amplitude when not V blanking and make V<sub>cm</sub> the testing value.

b)  $GY = 20 \log \frac{V_{cm} (mV_{P-P})}{200 (mV_{P-P})} (dB)$

Note3. Contrast Control Characteristics-1 "GY<sub>mid-1</sub>, GY<sub>max</sub>"

a) Test amplitude when not V blanking and make V<sub>co</sub> the testing value.

$GY_{mid-1} = V_{co}$

b)  $GY_{max} = 20 \log \frac{V_{cm}}{V_{co}} (dB)$

Note4. Contrast Control Characteristics-2 "GY<sub>min</sub>"

a) Test amplitude when not V blanking and make V<sub>c1</sub> the testing value.

b)  $GY_{min} = 20 \log \frac{V_{c1}}{V_{co}} (dB)$

Note5. Contrast Control Characteristics-3 "GY<sub>mid-2</sub>"

a) Test amplitude when not V blanking and make V<sub>c2</sub> the testing value.

b)  $GY_{mid-2} = 20 \log \frac{V_{c2}}{V_{co}} (dB)$

Note6. Video Tone Characteristics-1 "YT<sub>mid</sub>"

a) Test amplitude when not V blanking and make V<sub>to</sub> the testing value.

b)  $YT_{mid} = V_{to} (V_{P-P})$

Note7. Video Tone Characteristics-2 "YT<sub>min</sub>"

a) Test amplitude when not V blanking and make V<sub>t1</sub> the testing value.

b)  $YT_{min} = 20 \log \frac{V_{t1}}{V_{t0}} (dB)$

Note 8. Video Tone Characteristics-3 "YT<sub>max</sub>"

a) Test amplitude when not V blanking and make V<sub>t2</sub> the testing value.

b)  $YT_{max} = 20 \log \frac{V_{t2}}{V_{t0}} (dB)$

Note9. Peaking Value "YP"

- a) Test amplitude when not V blanking.
- b) Make V<sub>p1</sub> the testing value when SG2 is input.
- c) Make V<sub>p2</sub> the testing value when SG3 is input.

d)  $YP = 20 \log \frac{V_{p2}}{V_{p1}} (dB)$

Note10. Brightness Control Characteristics-1 "Y<sub>BRTmid</sub>"

a) Test DC voltage when not V blanking.

Note11. Brightness Control Characteristics-2 "Y<sub>BRTmin</sub>"

a) Same as Note10.

Note12. Brightness Control Characteristics-3 "Y<sub>BRTmax</sub>"

a) Same as Note10.

Note13. Frequency Characteristics "Y<sub>f</sub>"

- a) Test amplitude when not V blanking.
- b) Make V<sub>f1</sub> the testing value when SG2 is input.
- c) Make V<sub>f2</sub> the testing value when SG3 is input.

d)  $Y_f = 20 \log \frac{V_{f2}}{V_{f1}} (dB)$

Note14. Differential Gain "DG"

- a) Test amplitude when not V blanking.
- b) Make V<sub>G1</sub> the testing value when 2.4V is input into pin ⑨.
- c) Make V<sub>G2</sub> the testing value when 1.8V is input into pin ⑨.

d)  $DG = \frac{|V_{G1} - V_{G2}|}{V_{G2}} \times 100 (\%)$

Note15. Horizontal Blanking Threshold Voltage "H<sub>BLK TH</sub>"

- a) Apply voltage to pin ④ and increase from 8V.
- b) Test the voltage of pin ④ when signal ceases to be output by 1A.

Note16. Vertical Blanking Voltage "Y<sub>v.BLK</sub>"

a) Test voltage during V blanking.

Note17. DC Playback Ratio Control Characteristics "Y<sub>DGREG</sub>"

- a) Set S<sub>Ga</sub> of point C to 1.5V<sub>P-P</sub>.
- b) Test H.sync when S<sub>20</sub> is on and DC when not blanking. Make REG1 the testing value.
- c) Test in the same manner when S<sub>20</sub> is off and REG2 the testing value.
- d)  $Y_{DC REG} = REG1 - REG2$

Note18. Video DC Level Temperature Characteristics "ΔY<sub>oc/Ta</sub>"

a) Test DC voltage rate of change when ambient temperature is gradually raised from -20°C to +65°C.

## PAL/NTSC VIDEO CHROMA DEFLECTION

**Note19. Chroma Maximum Gain "GC"**

a) Test output amplitude (P-P) and make  $V_{GC}$  the testing value. (Input level is killer level +1dB)

$$b) GC = 20 \log \frac{V_{GC} \text{ (mV}_{P-P}\text{)}}{\text{Input Amplitude (mV}_{P-P}\text{)}} \text{ (dB)}$$

**Note20. ACC Characteristics-1 "ACC1"**

a) Test output amplitude (P-P).

b) Make  $V_{A0}$  the testing value when SG5 0dB is input.

c) Make  $V_{A1}$  the testing value when SG5 -22dB is input.

$$d) ACC1 = 20 \log \frac{V_{A1}}{V_{A0}} \text{ (dB)}$$

**Note21. ACC Characteristics-2 "ACC2"**

a) In the same manner as in Note20, make  $V_{A2}$  the testing value when SG5 + 6dB is input.

$$b) ACC2 = 20 \log \frac{V_{A2}}{V_{A0}} \text{ (dB)}$$

**Note22. Killer Operation Input "KIL"**

a) Gradually attenuate the level of SG5.

b) While monitoring DC voltage of pin ②, input level of SG5 when voltage becomes less than 1V.

**Note23. Killer Color Residual "D.KIL"**

a) Test output amplitude within 1H interval.

**Note24. Color Control Characteristics-1 "CC<sub>mid-1</sub>, CC<sub>max</sub>"**

a) Test output amplitude (P-P) and make  $V_{C10}$  the testing value.

$$CC_{mid-1} = V_{C10} \text{ (V}_{P-P}\text{)}$$

$$b) CC_{max} = 20 \log \frac{V_{C12}}{V_{C10}} \text{ (dB)}$$

**Note 25. Color Control Characteristics-2 "CC<sub>min</sub>"**

a) Test output amplitude (P-P) and make  $V_{C11}$  the testing value.

$$b) CC_{min} = 20 \log \frac{V_{C11}}{V_{C10}} \text{ (dB)}$$

**Note26. Color Control Characteristics-3 "CC<sub>mid-2</sub>"**

a) Test output amplitude (P-P) and make  $V_{C12}$  the testing value.

$$b) CC_{mid-2} = 20 \log \frac{V_{C12}}{V_{C10}} \text{ (dB)}$$

**Note27. APC Pull-In Range-1 "APC1"**

a) Set so that the frequency of SG6 is less than 4.433MHz and pin ② is Lo.

b) Gradually increase the frequency of SG6.

c) Test the frequency when the voltage of pin ② changes from Lo to Hi and make  $F_{AU}$  the testing value.

$$d) APC1 = 4433619 \text{ (Hz)} - F_{AU} \text{ (Hz)}$$

**Note28. APC Pull-In Range-2 "APC2"**

a) Set so that the frequency of SG6 is more than 4.434MHz and pin ② is Lo.

b) Gradually decrease the frequency of SG6.

c) Test the frequency when the voltage of pin ② changes from Lo to Hi and make  $F_{Ad}$  the testing value.

$$d) APC2 = F_{Ad} \text{ (Hz)} - 4433619 \text{ (Hz)}$$

**Note29. Demodulated Output DC Voltage "D<sub>dc</sub>"**

a) Test DC voltage at 1A, 2A and 3A.

**Note30. Demodulated Output DC Offset "D<sub>offset</sub>"**

a) Calculate each voltage difference of 1A2A, 2A3A and 3A1A from the testing value of Note29.

**Note31. Demodulation Ratio-1 "R/B"**

a) Test output amplitude and make  $D_{R-Y}$  the testing value.

$$b) R/B = \frac{D_{R-Y}}{D_{B-Y} \text{ (Testing Value at C15)}}$$

**Note32. Demodulation Ratio-2 "G/B"**

a) Test output amplitude and make  $D_{G-Y}$  the testing value.

$$b) G/B = \frac{D_{G-Y}}{D_{B-Y} \text{ (Testing Value at C15)}}$$

**Note33. Demodulated Output 1 H Level Difference "ΔD/H"**

a) Test both AC, DC for each 1H level difference.

**Note34. Demodulated Output Carrier Leak "Cleak"**

a) Test output carrier element for 1A, 2A and 3A.

**Note35. NTSC Operation Control Voltage "V<sub>NTSC</sub>"**

a) Gradually decrease voltage of 29A from the area of 8V.

b) Test the 29A voltage when signal ceases to be output by 1A.

**Note36. Demodulation Ratio (NTSC)-1 "NTSC R/B"**

a) Test output amplitude and make  $NTSC_R$  the testing value.

$$b) NTSC R/B = \frac{NTSC_R}{NTSC_B \text{ (Testing Value at C22)}}$$

**Note37. Demodulation Ratio (NTSC)-2 "NTSC G/B"**

a) Test output amplitude and make  $NTSC_G$  the testing value.

$$b) NTSC G/B = \frac{NTSC_G}{NTSC_B \text{ (Testing Value at C22)}}$$

**Note38. PAL/NTSC Demodulated Output DC Voltage Difference "VP/N"**

a) Test the difference in DC voltage when  $S_{29}$  is on and when it is off.

**Note39. Killer ON/OFF Modulated Output DC Voltage Difference "ΔD/KIL"**

a) Make  $DD1$  the voltage difference when  $S_{26}$  is on, and make  $DD2$  the voltage difference when  $S_{26}$  is off.

$$b) \Delta D/KIL = |DD1 - DD2|$$

**Note40. Service Switch Operation "SS"**

- a) No output signal from ④
- b) No vertical sync pulse from ⑬
- c) Voltage of ② drops below 1V.
- d) Check a, b and c.

**Note41. Demodulated Output Bandwidth "Dew"**

- a) Set frequency of SG8 to 4.5MHz, and test output amplitude of ①, ② and ③.
- b) Gradually increase the frequency of SG8.
- c) Test output frequency of ①, ② and ③ when output amplitude is 3dB less than when 4.5MHz is input.

**Note42. Chroma Input Dynamic Range "CD"**

- a) Increase the level of SG5 and test the input amplitude when output becomes distorted.

**Note43. PAL Demodulated Phase Angle "ZR-Y-P, ZG-Y-P"**

- a) Make ZR-Y-P the phase difference of 1A and 2A.
- b) Make ZG-Y-P the phase difference of 1A and 3A.

**Note44. NTSC Demodulated Phase Angle "ZR-Y-N, ZG-Y-N"**

- a) Make ZR-Y-N the phase difference of 1A and 2A.
- b) Make ZG-Y-N the phase difference of 1A and 3A.

**Note45. NTSC Tint "T<sub>min</sub>, T<sub>max</sub>"**

- a) Set oscilloscope to X-Y. Connect 1A to X and 2A to Y.
- b) Open 29A and set SG6 frequency to 4.433619MHz.
- c) At this time the oscilloscope waveform is shown as 180°.
- d) Make T<sub>min</sub> the remainder of subtracting 180° from the angle when 29A was set to 4V.
- e) Make T<sub>max</sub> the remainder of subtracting 180° from the angle when 29A was set to 1V.

**Note46. Demodulated Output DC Voltage Temperature Characteristics "Doc/Ta"**

- a) Test output voltage rate of change when ambient temperature is gradually raised from -20°C to +65°C.

**Note47. Horizontal Oscillator Starting Voltage "V<sub>Bmin</sub>"**

- a) Increase V<sub>cc</sub> from 0V.
- b) Test V<sub>cc</sub> voltage where the output waveform cycle of ⑥ is approx. 64μs.

**Note48. Horizontal Freerun Frequency "f<sub>H</sub>"**

**Note49. Horizontal Pull-In Range-1 "f<sub>PH1L</sub>, f<sub>PH1H</sub>"**

- a) Decrease the frequency of input signal so that the SGB input signal and pin ⑥ output waveform are not synchronized.
- b) Gradually increase the frequency of SGB.
- c) Test the SGB frequency when SGB and pin ⑥ output waveform become synchronized and make f<sub>L1</sub> the testing value.
- d) f<sub>PH1L</sub> = f<sub>L1</sub> - f<sub>H</sub> (Testing Value at Note48)
- e) Test the upper side pull-in in the same manner and make f<sub>H1</sub> the SGB frequency when the two become synchronized.
- f) f<sub>PH1H</sub> = f<sub>H1</sub> - f<sub>H</sub> (Testing Value at Note 48)

**Note50. Horizontal Pull-In Range-2 "f<sub>PH2L</sub>, f<sub>PH2H</sub>"**

- a) Test in the same manner as Note49 and make f<sub>L2</sub> the lower side pull-in frequency, and make f<sub>H2</sub> the upper side pull-in frequency.
- b) f<sub>PH2L</sub> = f<sub>L2</sub> - f<sub>H</sub> (Testing Value at Note48)
- c) f<sub>PH2H</sub> = f<sub>H2</sub> - f<sub>H</sub> (Testing Value at Note48)

**Note51. VCR Switch Threshold Voltage "VCR SW"**

- a) Set SGB frequency of Note49 immediately preceding pull-in.
- b) Increase 22A voltage from 6V and test voltage of pin ② at time of pull-in.

**Note52. Horizontal Output Pulse Amplitude "τ<sub>H</sub>"**

**Note53. Horizontal Output Voltage "V<sub>Hmin</sub>, V<sub>Hmax</sub>"**

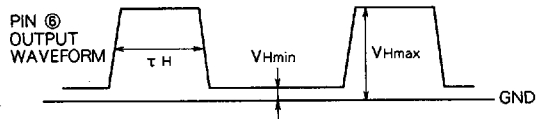

**Note54. Burst Gate Pulse Position "t<sub>GP</sub>"**

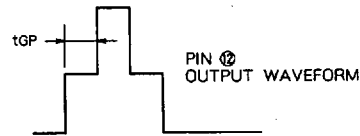

**Note55. Vertical Pull-In Range 50 (Hz) "f<sub>pv50</sub>"**

- a) Increase the frequency of input signal so that the SGC input signal and pin ⑬ output waveform are not synchronized.
- b) Decrease the frequency of SGC and test the SGC frequency when SGC and the output waveform of pin ⑬ become synchronized.

**Note56. Vertical Pull-In Range 60 (Hz) "f<sub>pv60</sub>"**

- a) Same as Note55.

**Note57. Vertical Output Pulse Amplitude 50 (Hz) "τ<sub>v50</sub>"**

**Note58. Vertical Output Pulse Amplitude 60 (Hz) "τ<sub>v60</sub>"**

**Note59. Vertical Output Maximum Voltage "V<sub>vmax</sub>"**

**Note60. Vertical Output Minimum Voltage "V<sub>vmin</sub>"**

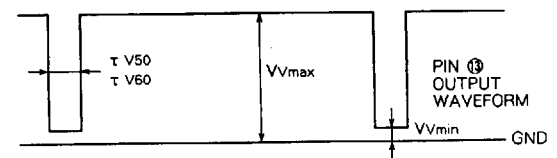

**Note61. Ramp Peak Voltage "P<sub>ramp</sub>"**

PAL/NTSC VIDEO CHROMA DEFLECTION

**Note62. Ramp Amplitude "V<sub>ramp</sub>"**

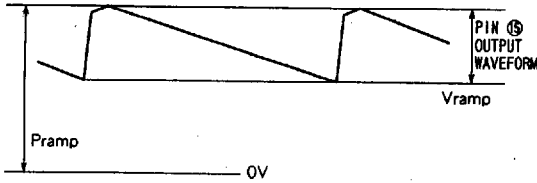

**Note63. Vertical Open Loop Gain "G<sub>v</sub>"**

- a) Check ⑩ and adjust the voltage at 14A lest the waveform should be distorted (approx. 3.5V).
- b) Test the output amplitude of pin ⑩ and make V<sub>vo</sub> the testing value.
- c)  $G_v = 20 \log \frac{V_{vo} \text{ (mV}_{p-p})}{\text{Input Amplitude (} \approx 15.8\text{mV}_{p-p})}$  (dB)

**Note64. Sync Separation Input Sensitivity Current "I<sub>ss</sub>"**

- a) Increase I<sub>s</sub> from 0mA.
- b) Test I<sub>s</sub> when burst gate pulse ceases to be output by ⑫.

**Note65. Burst Gate Pulse Timing-1 "T<sub>BGP1</sub>"**

- a) Test the time from SGa rise to burst gate pulse rise.

**Note66. Burst Gate Pulse Timing-2 "T<sub>BGP2</sub>"**

- a) Test burst gate pulse amplitude.

**Note67. Flyback Pulse Clamp Voltage "V<sub>FBP</sub>"**

**Note68. Burst Gate Pulse Voltage "V<sub>BGP</sub>"**



**Note69. AFC2 Interlock Range "AFC2<sub>min</sub>, AFC2<sub>max</sub>"**

- a) Trigger external pulse generator by pin ⑥ output.
- b) Generate flyback pulse with external pulse generator, and input to 12B.
- c) While gradually decreasing the pulse generator's pulse delay, when the position of pin ⑫ waveform largely differs from the output waveform of pin ⑥, make AFC2<sub>min</sub> the time between ⑥ rise and flyback pulse rise.
- d) Increasing the pulse generator's pulse delay, test in the same manner to find the value of AFC2<sub>max</sub>.

**Note70. AFC2 Loop Gain "AFC2G"**

- a) Test the burst gate pulse position (t<sub>GP</sub>) at AFC2<sub>min</sub> of Note69 + 1μs, and make t<sub>GPmin</sub> the testing value.
- b) Test the burst gate pulse position at AFC2<sub>max</sub> - 1μs and make t<sub>GPmax</sub> the testing value.
- c)  $AFC2G = 20 \log \frac{AFC2_{max} - AFC2_{min} \text{ (} \mu\text{sec)}}{t_{GPmin} - t_{GPmax} \text{ (} \mu\text{sec)}}$

**Precautions Concerning Electrical Characteristics**

- 1) Adjust the one-shot multivibrator's potentiometer so that the timing of the horizontal input flyback pulse of pin ⑫ and pulse amplitude are as shown in the figure below.
- 2) Standard Conditions of Deflection Section for Testing Video/Chroma Sections

Input A	9	14A	15A	V <sub>cc</sub>	S <sub>6</sub>	S <sub>14</sub>	S <sub>16</sub>	S <sub>17</sub>	S <sub>22</sub>	S <sub>7</sub>
SGa	-	8V	-		ON	OFF	1	OFF	OFF	ON

"-" indicates OPEN.

- 3) Standard Conditions of Video/Chroma Sections for Testing Deflection Section

Input C,D,E	17A	19	20A	23A	25A	29A	S <sub>24-1</sub>	S <sub>26</sub>	S <sub>29</sub>	S <sub>32</sub>	S <sub>20</sub>
	-	-	5.5V	-	5.5V	-	ON	OFF	OFF	1	OFF

"-" indicates OPEN.

- 4) Unless designated otherwise, V<sub>cc</sub>=11V, T<sub>a</sub>=25°C.

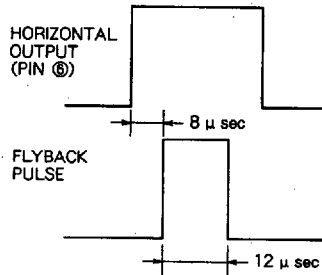



# M52016SP

## PAL/NTSC VIDEO CHROMA DEFLECTION

### VIDEO/CHROMA INPUT IMPEDANCE

Symbol	Parameter	Test point	Test conditions	Limits			Unit
				Min.	Typ.	Max.	
R <sub>i</sub> (18)	Video input resistance	18	V <sub>cc</sub> = 12V, test with LCR meter, 4.43MHz 0.1V		5		k Ω
C <sub>i</sub> (18)	Video input capacitance	18			5.5		pF
R <sub>i</sub> (17)	Picture quality input resistance	17			9.7		k Ω
C <sub>i</sub> (17)	Picture quality input capacitance	17			6		pF
R <sub>i</sub> (22)	Chroma input resistance	22			2		k Ω
C <sub>i</sub> (22)	Chroma input capacitance	22			20		pF
R <sub>i</sub> (30)	B - Y input resistance	30			3		k Ω
C <sub>i</sub> (30)	B - Y input capacitance	30			7		pF
R <sub>i</sub> (32)	R - Y input resistance	32			3		k Ω
C <sub>i</sub> (32)	R - Y input capacitance	32			7		pF

### INPUT IMPEDANCE TESTING CIRCUIT

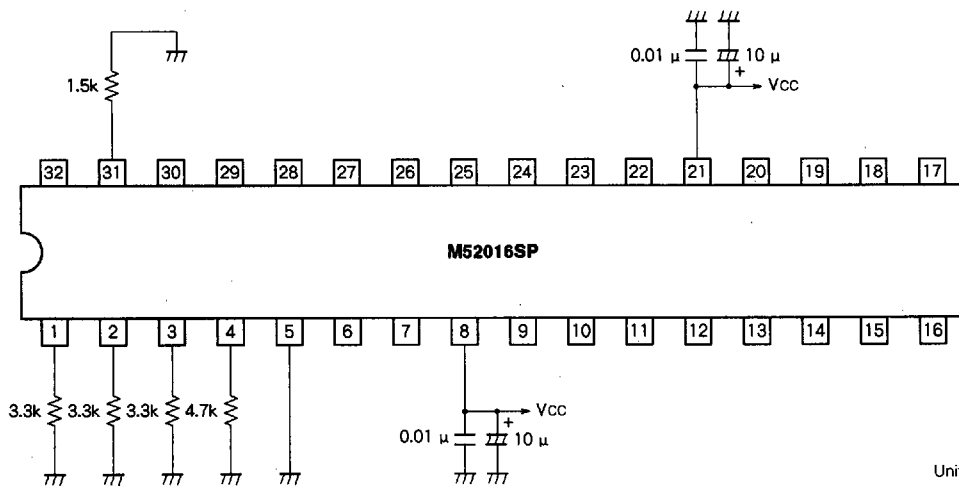

Units Resistance: Ω  
Capacitance: F





M52016SP

PAL/NTSC VIDEO CHROMA DEFLECTION

INPUT SIGNAL

TYPICAL CHARACTERISTICS

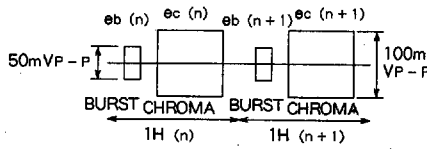
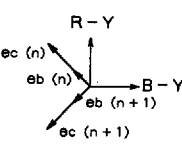
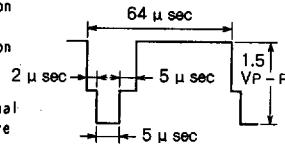
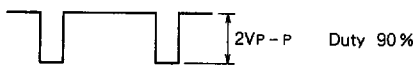
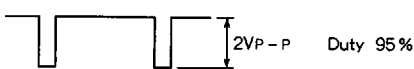
SG No.	Signals
SG1	100kHz CW 3VP-P
SG2	100kHz CW 200mVP-P
SG3	2MHz CW 200mVP-P
SG4	5MHz CW 200mVP-P
SG5	<p>PAL Simple chroma signal 0dB</p>  <p>fsb = fsc = 4.433619MHz (Same phase)</p> <p>The phase correlation between the about signals is outlined in the figure on the right. The phase correlation with burst of ec (n) and ec (n+1) does not always have to be as shown in the figure on the right, and in particular must be adjustable according to conditions when testing phase correlation.</p> 
SG6	With PAL simple chroma signals for SG5, the phase of burst and chroma signals should be the same and the frequency should be adjustable.
SG7	4.42MHz CW 0.2~0.5VP-P
SG8	4~6MHz CW
SG9	SG5 $\bar{c}$ , fsb (burst) = 4.433619MHz, fsc (chroma) = 4.543MHz
SGa	<p>For sync separation input, make input for sync separation PAL-type APL 100% 1.5VP-P normal complex video signal shown in the figure on the right.</p> 
SGb	 <p>2VP-P Duty 90%</p>
SGc	 <p>2VP-P Duty 95%</p>
SGd	2kHz CW 500mVP-P = 0dB

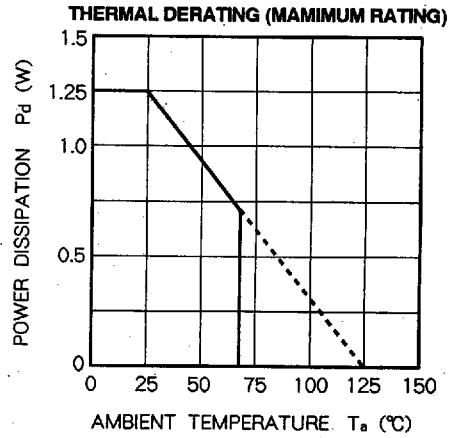



This datasheet has been downloaded from:

[www.DatasheetCatalog.com](http://www.DatasheetCatalog.com)

Datasheets for electronic components.