



## FSY5015X05L(M)(H) FSY5015X12L(M)(H) FSY5015X24L(M)(H)

### Features

Size: 50×50×15mm(2.36×2.36×0.59in)  
 Frame/Impeller: Reinforced Plastic UL94V-0  
 Bearings: Ball Bearing&Sleeve Bearing  
 Life Expectancy:50,000 Hours at 20°C-Ball  
 30,000 Hours at 20°C-Sleeve  
 Approvals: UL CUL TUV CE RoHS  
 Weight: 30g

**E318377** CE TUV AE50078978  
 ▪ RoHS Compliant

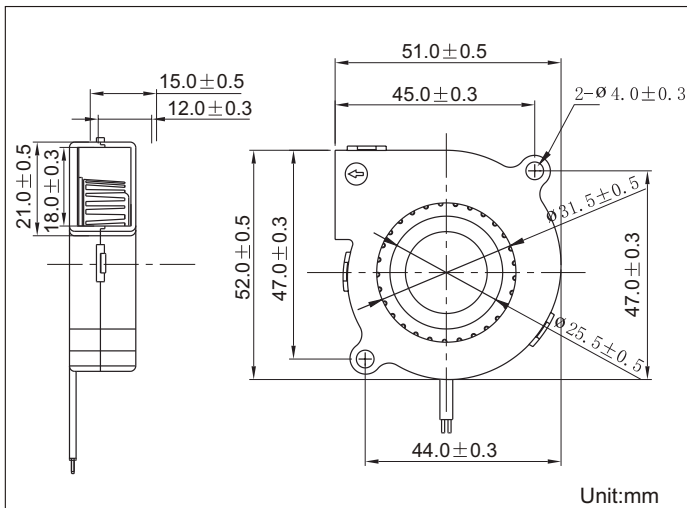

### Air Flow vs Air Pressure

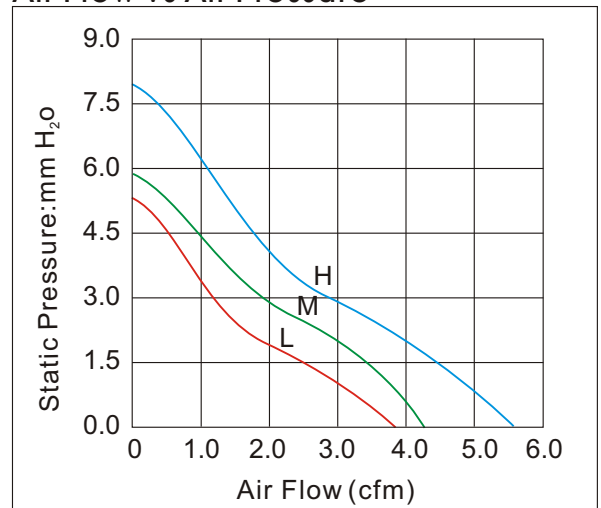

### Performance

Model	Bearing System X			Rated Voltage (V)	Current (A)	Input Power (W)	Nominal Speed (R.P.M)	Air Flow (CFM)	Air Pressure (mm-H <sub>2</sub> O)	Noise (dBA)
	S	B	D							
FSY5015X05L	✓	✓	✓	5	0.15	0.75	3500	3.75	5.15	28
FSY5015X05M	✓	✓	✓	5	0.22	1.10	4000	4.21	5.88	30
FSY5015X05H	✓	✓	✓	5	0.35	1.75	5000	5.55	7.35	33
FSY5015X12L	✓	✓	✓	12	0.10	1.20	3500	3.75	5.15	28
FSY5015X12M	✓	✓	✓	12	0.15	1.80	4000	4.21	5.88	30
FSY5015X12H	✓	✓	✓	12	0.20	2.40	5000	5.55	7.35	33
FSY5015X24L	✓	✓	✓	24	0.08	1.92	3500	3.75	5.15	28
FSY5015X24M	✓	✓	✓	24	0.10	2.40	4000	4.21	5.88	30
FSY5015X24H	✓	✓	✓	24	0.15	3.60	5000	5.55	7.35	33

Product specification contained herein may be changed without prior notice.

It is therefore advisable to contact FONSONING ELECTRONICS before proceeding with the design of equipment incorporating this product.

Fonsoning Electronics Corporation 4/F, Building 1, Fumin Yuexinwei Industrial District, Guanlan Town, Shenzhen  
 Tel: 86-755-28015525 • Fax: 86-755-89584557 • E-mail: fsy@fonsoning.com • www.fonsoning.com