



广州市番禺奥迪威电子有限公司

Audiowell Electronics (Guangzhou) Co., Ltd.

地址: 中国广东省广州市番禺区迎宾路东升工业区

邮政编码: 511400

Add: Dongsheng Industrial Park, Yingbin Road, Panyu, Guangzhou 511400, China

Tel: +86-20-84802041 84802405 84871596 34516785

Fax: 84665207



# 承 认 书

## SPECIFICATION FOR APPROVAL

客 户

CUSTOMER

奥迪威料号 T/R60-10H0Z-01

客户料号

AUDIOWELL P/N

CUST P/N

品 名 超声探头

日期 2012.05.22

DESCRIPTION

DATE

NO.

版本:

### 超声波传感器明细

#### ULTRASONIC SENSOR SPECIFICATIONS

1. 型号 MODEL
2. 电性能明细 ELECTRICAL SPECIFICATIONS
3. 外观尺寸 DIMENSIONS
4. 测试线路 TEST CIRCUIT
5. 指向测试 DIRECTIVITY TEST
6. 环境特征 ENVIRONMENTAL CHARACTERISTICS
7. 测试条件器 TEST CONDITIONS AND INSTRUMENTS
8. 备注 NOTES
9. 测试报告 TEST REPORTS

客户签认 CUSTOMER APPROVAL	承认 APPD.	承认章 COMPANY CHOP

出图 DRAWING	制作 DWN.	审核 CHK.	核准 APPD.

注: 承认书一式两份, 请返回一份 PLEASE SENT ONE OF THE SAME TWO BACK

广州市番禺奥迪威电子有限公司

AUDIOWELL ELECTRONICS (GUANGZHOU) CO. LTD

广州番禺市桥镇迎宾路东升工业区

DONG SHENG INDUSTRIAL PARK, YINGBIN ROAD,

PANYU, GUANGZHOU, CHINA

TEL: (020) 84871596 FAX: (020) 84665207

Http: //www.audiowell.com

**PIEZO ULTRASONIC SENSOR SPECIFICATIONS**

■MODEL: T/R60-10H0Z-01

■ELECTRICAL SPECIFICATION:

1	Center frequency(KHz)	60±1.0
2	Echo Sensitivity(mV)	≥150 (FIG1 SIMULATION TEST CIRCUIT)
3	Decay Time(ms)	≤1.0 (FIG1 SIMULATION TEST CIRCUIT)
4	Directivity (deg)	80±15
5	Capacitance (pF)	1600±15%
6	Allowable Maximum Input Voltage(Vp-p)	140 (60KHz,Pulse width 0.333mS, interval 20ms)
7	Mean Time To Failure(h)	50000
8	Operating Temperature(°C)	-40~+80
9	Storage temperature(°C)	-40~+85

■APPEARANCE AND DIMENSIONS

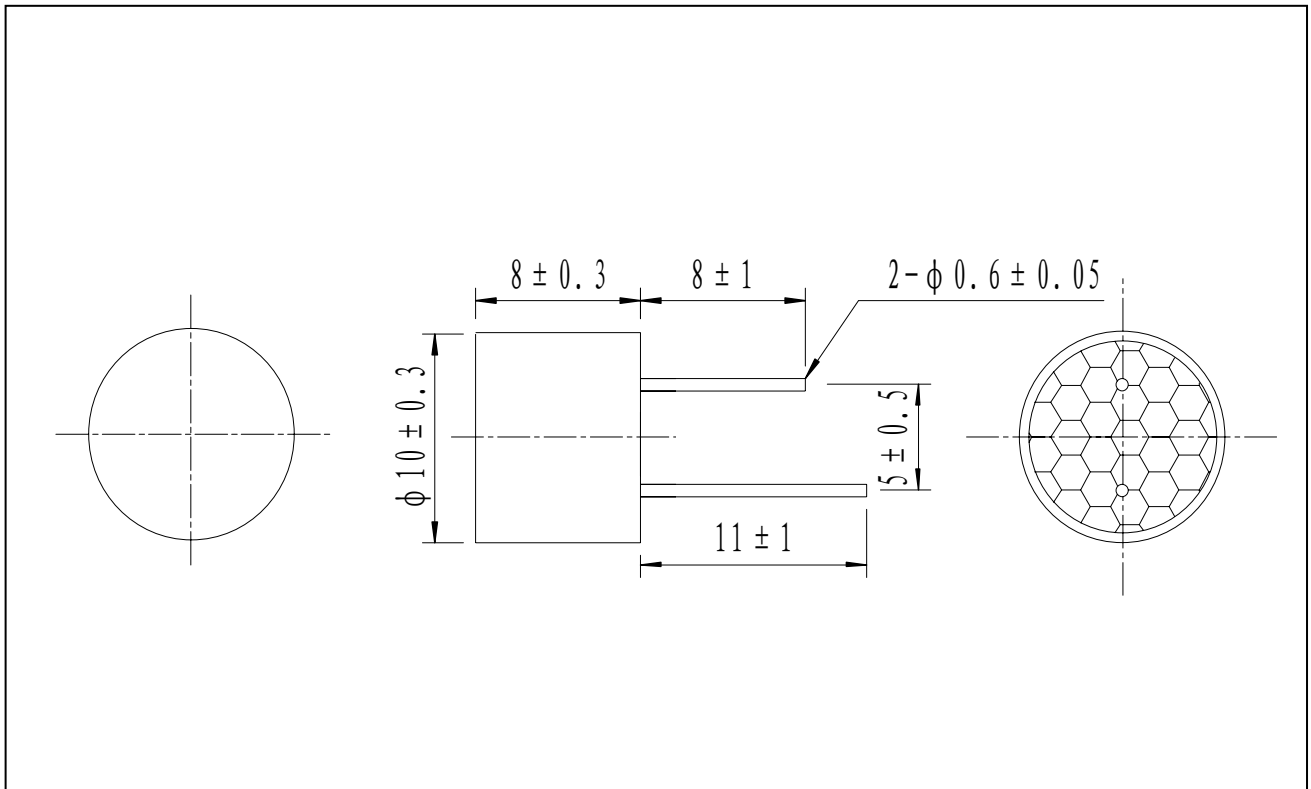

**Note:** All materials are RoHS, But Piezo is released

## ■ SIMULATION TEST CIRCUIT

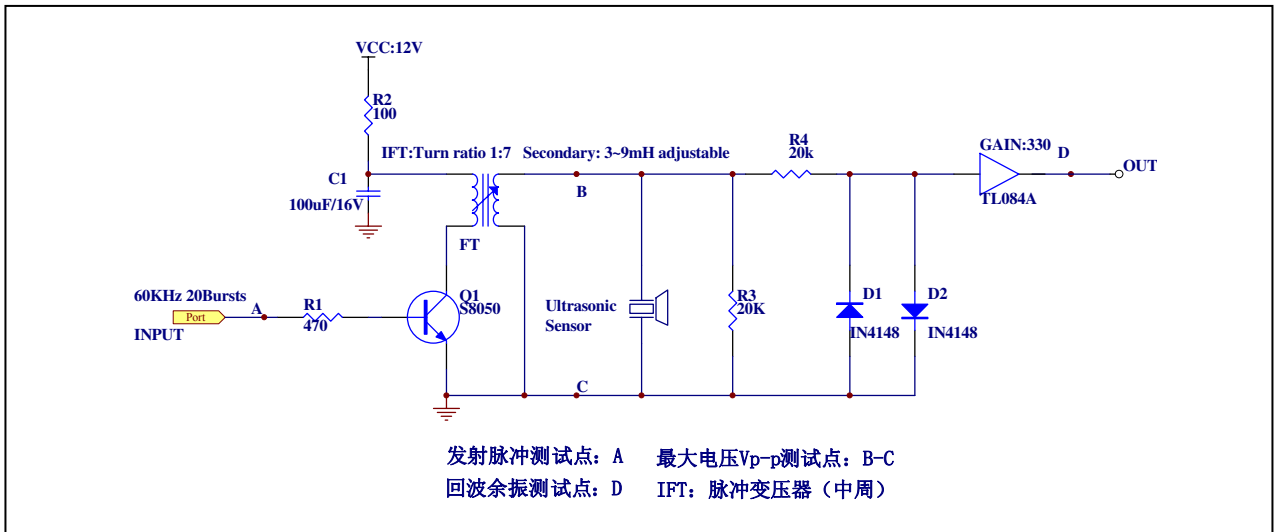

FIG.1

## ■ DIRECTIVITY TEST

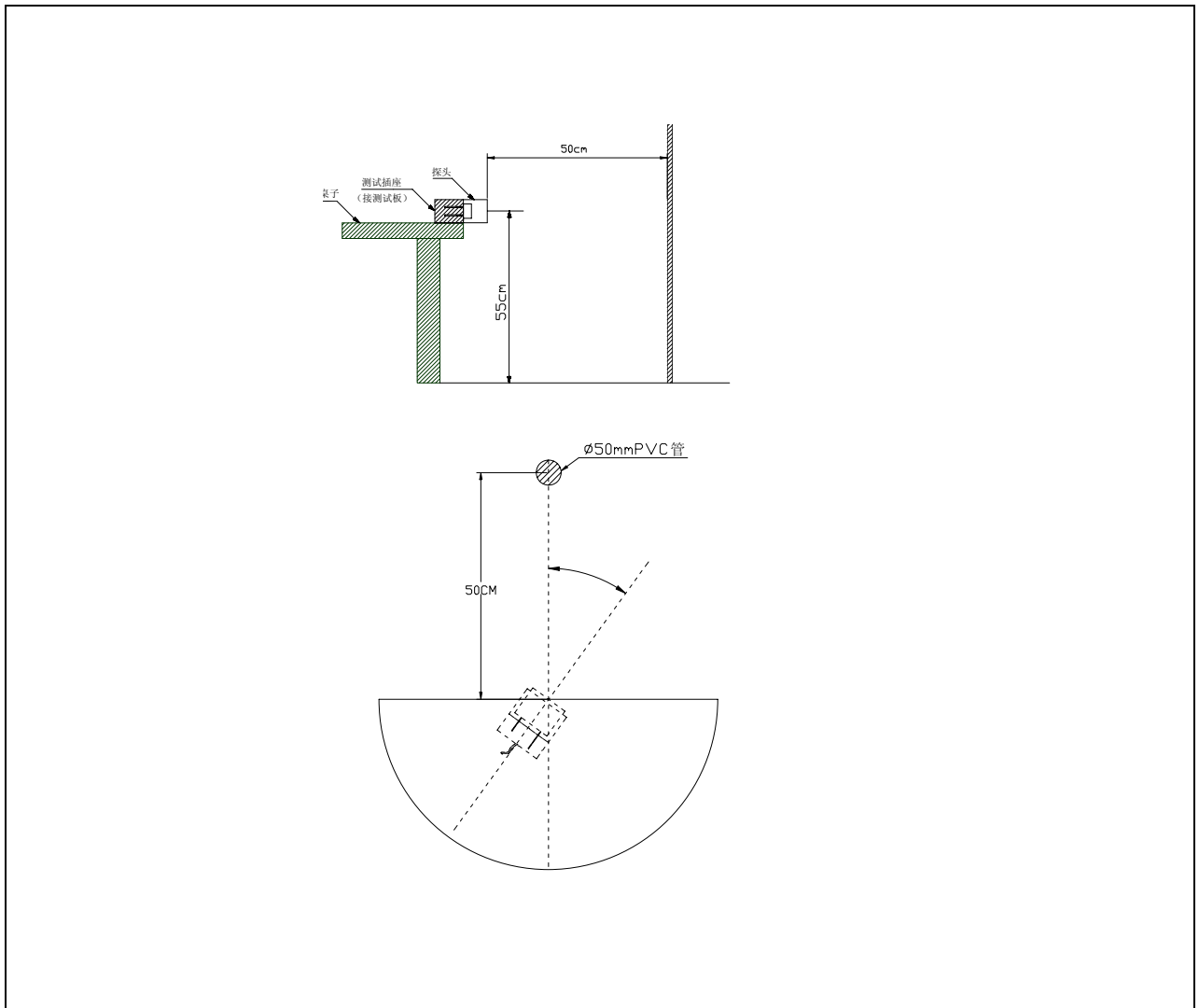
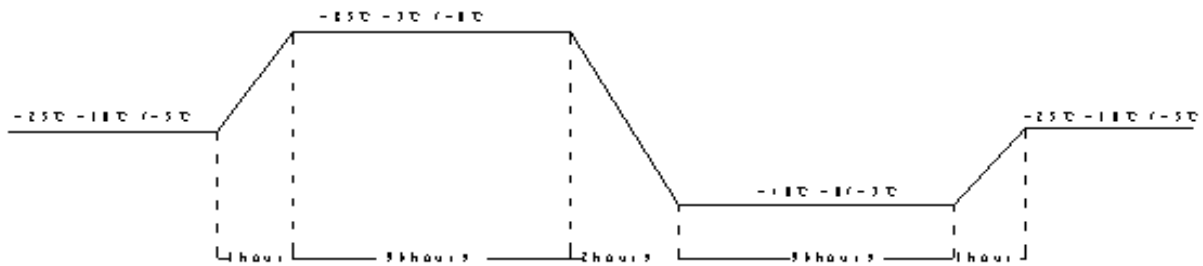

FIG. 2

## ■ ENVIRONMENT CHARACTERISTICS

CONDITIONS	STANDARDS
High and low temperature (from -40°C to +80°C at a relative humidity of 30%)	Sensitivity shall not change by more than 30% all of the conditions.  All sensitivity shall be within 30% of the specified values after the device is subjected to any or all of the conditions.
Humidity of 10% to 90% at the temperature of 25°C	
Storage at +85°C for 96 hours and at -40°C for 96 hours followed by a normalization period at 25°C. As shown in FIG.3.	
Operation at 95% relative humidity and 40°C for 100 hours, followed by a normalization period of 24 hours at 30% and 25°C. As shown in FIG.4.	
Vibration at 10Hz to 55Hz, 1.5mm amplitude. 1 minute sweep. X,Y,Z,3 each axis for 3 hours. As shown in FIG.5	

**FIG 3 TEMP. TEST**



**FIG 4 TEMP. / HUMIDITY TEST**

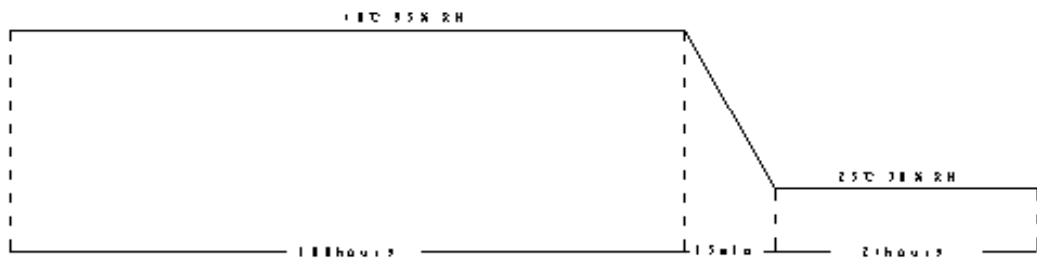

**FIG 5 VIBRATION TEST**

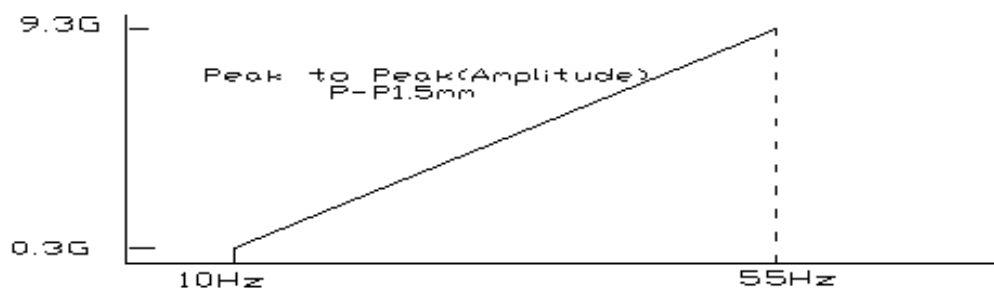

## ■ TESTING INSTRUMENT AND CONDITION LIST

No.	Testing item	Testing Equipment/Methods	Testing conditions
1	Resonant Frequency	Piezoelectric Transducer Resistance Testing System	Testing temperature :25±2°C
2	Echo Sensitivity	According to Fig. 1 Test Circuit	Distance to obstacle: 1 meter , Obstacle: organic glass board with 20CM*20CM*1.0CM 1.The inductance :4mH, Q m Value: 60-80, Pulse : 20 2.The Minimum detect distance≥35cm 3.The acoustic system without coupling
3	Ring Time	According to Fig. 1 Test Circuit	The sensor surface is covered by 100mm thickness of sponge 1.The inductance :4mH,Qm Value: 60-80, Max Pulse ≤20 2.The Minimum detect distance≥35cm 3.The acoustic system without coupling
4	Directivity	According to Fig.1 & Fig. 2 Test Circuit	In normal room temperature, the distance to the ground: 55cm the distance to the obstacle: 50cm the obstacle: diameter of 50mm PVC pipe, the obstacle height: 1 meter Note: there is no other obstacle in a circumference of 1 meter.
5	Capacitance	Digital LC	Testing temperature :25±2°C
6	Maximum Input Voltage (V p-p)	According to Fig.1 Test Circuit Oscillograph: Tektronix TDS1002	Pulse Width: 0.333mS, Interval :20mS
7	Mean Time to Failure	Aging Equipment AWHY001	Testing temperature :25±2°C
8	Operating Temperature(°C)	High-Low alternating temperature Cabinet	In normal room temperature, according to the Fig. 4 test circuit
9	Storage Temperature(°C)	High-Low alternating temperature Cabinet	In normal room temperature, according to the Fig. 4 test circuit

## ■ NOTE:

### 1. DESIGN RESTRICTION/PRECAUTIONS

- This sensor is designed for use in air environment. Do not use it in liquid.
- In the case where secondary accidents due to operation failure or malfunctions can be anticipated, add a fail safe function to the design.
- In the case where this sensor is to be hold in housing, use soft buffer between sensor and housing. The front convex part of this sensor vibrates in large extension. If this part is hold, its characteristics will vary. The top must be free to vibrate.

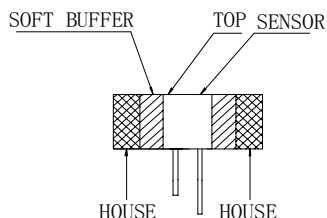

### 2. USAGE RESTRICTION/PRECAUTIONS:

- To prevent sensor malfunctions, operational failure or any deterioration of its characteristics, do not use this sensor in the following, or similar conditions.
  - a) In strong shock or vibration.
  - b) In high temperature and humidity for a long time.
  - c) In corrosive gases or sea breeze.
  - d) In an atmosphere of organic solvents.
  - e) In dirty and dusty environments that may contaminate the sensor front.
  - f) Over specified allowable input voltage( $V_{p-p}$ )
- Do not solder adding stress on outer lead, also do not apply stress like spin or pressure just after soldering.

In case you form the leads, support the root firmly.

### 3. WARRANTY:

#### ■ Period

Warranty period is three years after delivery.

#### ■ Scope

Defective sensors attributable to manufacturer' responsibility shall be replaced for free during the warranty period.

However, following cases are out of the scope.

- a) Unsuitable handling or misuse by user.
  - b) Modification or repair by user.
  - c) Any other cases not due to manufacturer's responsibility such as natural calamity, accident .etc.
- This scope covers only replacement.

Any loss derived from failure or malfunction of the sensor, or cost on replacing is excluded from this warranty scope.