

SPECIFICATION

受 控

Customer : QUARTZ

Applied To :

Product Name : Piezo Siren

Model Name : KPS-G5520-K1206

Drawing No. : KTC1206R

Compliance with ROHS

Signature of Approval

--

Signature of KEPO

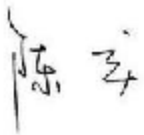
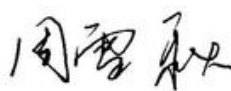
Approved by	Checked by	Issued by	Date
			



宁波凯普电子有限公司

宁波东钱湖镇东钱湖工业区宝源路 25 号

TEL:+86-574-88370330 FAX:+86-574-88370329

No.25 Baoyuan road Dongqian Lake, Industry Area, Dongqian town,
Ningbo City, China(Post Code:315121)

Sales@chinaacoustic.com www.chinaacoustic.com

Specification for Piezo Siren	Page	2/9
	Revision No.	1.0
	Drawing No.	KTC1206R
Model No. : KPS-G5520-K1206		

CONTENTS

1. Scope
范围
2. General
概要
3. Electrical and Acoustic Characteristics.
电声参数
4. Reliability Test
可靠性试验
5. Measurement Block Diagram
测试图
6. Structure
结构
7. Dimensions
尺寸
8. Packing
包装
9. Revision
履历表

Specification for Piezo Siren	Page	3/9
	Revision No.	1.0
	Drawing No.	KTC1206R
Model No. : KPS-G5520-K1206		

1. Scope

This product specification is applied to the siren used for sounder in alarm systems. Please contact us when using this product for any other applications than described in the above.

本规格书适用于报警器，通常它用在系统中做报警或提示，如果将该产品用于其它领域，请与我们联系。

2. General

- 2.1 Out- Diemeter : Ø54.5mm
 外径: Ø54.5 mm
- 2.2 Height 18mm
 高度: 18 mm
- 2.3 Weight: 45 g.
 重量: 45克
- 2.4 Operating Temperature range:
 -20~+60℃ without loss of function
 工作温度: -20~+60℃
- 2.5 Store Temperature range:
 -30~+70℃ without loss of function
 储藏温度: -30~+70℃

3. Electrical and Acoustic Characteristics.

Test condition : 15 ~ 35 °C, 25% ~ 85% RH, 860~1060 mbar

测试条件: 15~35 °C, 25%~85%RH, 860~1060mbar

	Items 项目	Specification 规格
1	Rated Voltage 额定电压	12VDC
2	Operating Voltage 工作电压	6-16VDC
3	Max.Rated Current 额定电流	≤160mA/12VDC
4	Min.Sound Pressure Level 额定声压	103dB/12VDC/30cm
5	Tone Nature 音调	Siren
6	Housing Material/Color 壳体材质/颜色	ABS/Black
7		
8		
9		
10		

Specification for Piezo Siren	Page	4/9
	Revision No.	1.0
	Drawing No.	KTC1206R
Model No. : KPS-G5520-K1206		

4. Reliability Test

After test(1~6item), the Piezo Siren S.P.L . difference shall be within $\pm 10\text{dB}$, and the appearance not exist any change to be harmful to normal operation(e.g.cracks,rusts,damages and especially distortion).

在1-6项试验后，报警器的声压变化值在 $\pm 10\text{dB}$ 之内，外观无变化（例如：开裂、生锈、损伤、变形等现象）。

	Item	Specification
1	High Temperature Test 高温试验	<p>After being woked in a chamber with $+70\pm 2\text{ }^\circ\text{C}$ for 2h and then being placed in natural condition for 2h, sounder shall be measured.</p> <p>将产品置于 $+70\pm 2\text{ }^\circ\text{C}$ 试验箱中，先工作 2小时，然后在正常大气压条件下恢复2小时后，进行测量</p>
2	Low Temperature Test 低温试验	<p>First being worked in a chamber with $-30\pm 2\text{ }^\circ\text{C}$ for 2h and then being placed in a chamber with $-30\pm 2\text{ }^\circ\text{C}$ for 16h, finally being placed in natural condtion for 2h, sounder shall be measured.</p> <p>将产品置于 $-30\pm 2\text{ }^\circ\text{C}$ 试验箱中，先工作 2小时，再放置16小时，然后在正常大气压条件下恢复2小时后，进行测量</p>
3	Humidity Test 潮湿试验	<p>After being placed in a chamber with 90 to 95%R.H. at $+40\pm\text{ }^\circ\text{C}$ for 2 h and then being placed in natural condition for 2h , sounder shall be measured.</p> <p>将产品置于湿度为 90-95%R.H，温度为 $40\pm 2\text{ }^\circ\text{C}$ 试验箱中 2小时，然后在正常大气压条件下恢复2小时后，进行测量</p>
4	Shock 耐冲击性	<p>Under acceleration of peak $100\text{m/s}^2(10\text{g})$ & half sine wave pulse (pulse time is 16ms)condition.run into product 1000 times continuously.</p> <p>峰值加速度 $100\text{m/s}^2(10\text{g})$,脉冲持续时间为 16ms的半正弦波脉冲对试样连续碰撞 1000次，测试报警器.</p>

Specification for Piezo Siren Model No. : KPS-G5520-K1206	Page	5/9
	Revision No.	1.0
	Drawing No.	KTC1206R

4. Reliability Test

	Item	Specification
5	Drop Test 跌落试验	Siren packed in the carton are dropped in six direction from the height of 50cm to the concrete floor. 跌落高度50cm,6个不同方向整箱跌落到水泥地, 试验后进行测量.
6	Vibration Resistance 振动试验	Siren shall be measured after being applied vibration of amplitude of 1.5mm with 10to 30Hz band of vibration frequency to each of 3 perpendicular directions for 2 hour. 振幅为1.5mm, 频率为10-30Hz,三个不同轴方向各振动2小时, 试验后进行测量.

5. Measurement Block Diagram

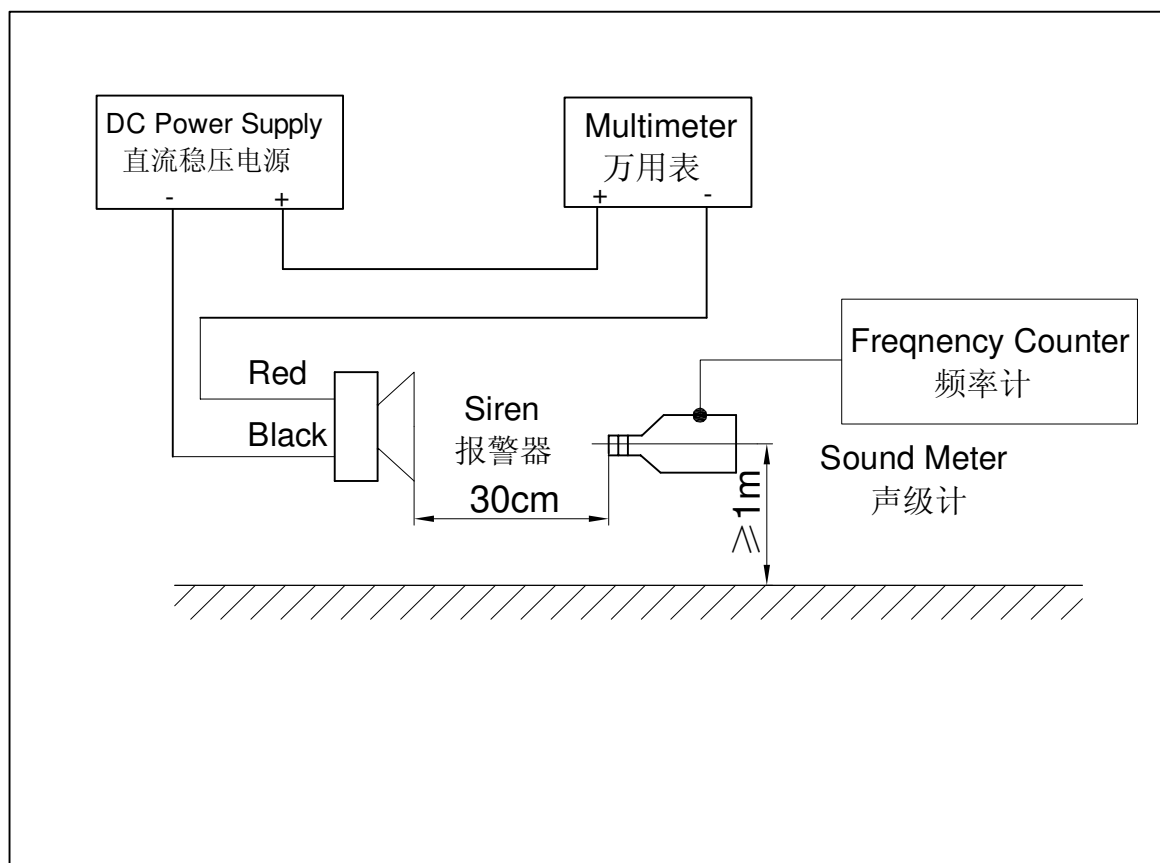

Specification for Piezo Siren	Page	6/9
	Revision No.	1.0
Model No. : KPS-G5520-K1206	Drawing No.	KTC1206R

6. Structure

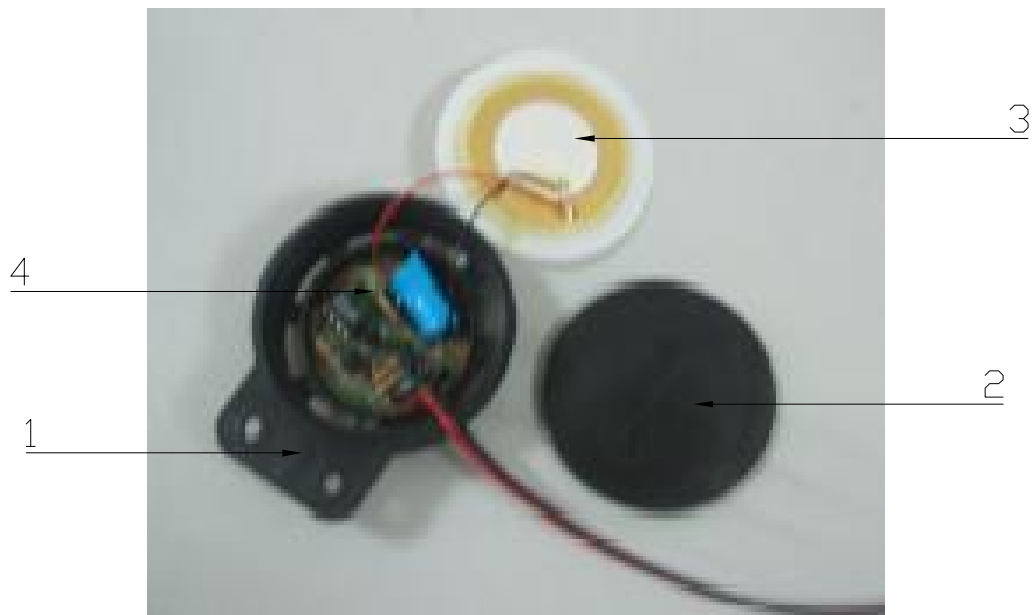

4	PCB 印制板组件	1		
3	Piezo-Element 蜂鸣片	1	H65	
			Piezo Ceramic	
2	Cover/Color 后盖/颜色	1	ABS/Black	
1	Housing/Color 外壳/颜色	1	ABS/Black	
No.	Part Name 型号	Q'TY	Material 材质	SGS 编号

Specification for Piezo Siren	Page	7/9
	Revision No.	1.0
Model No. : KPS-G5520-K1206	Drawing No.	KTC1206R

7. Dimensions

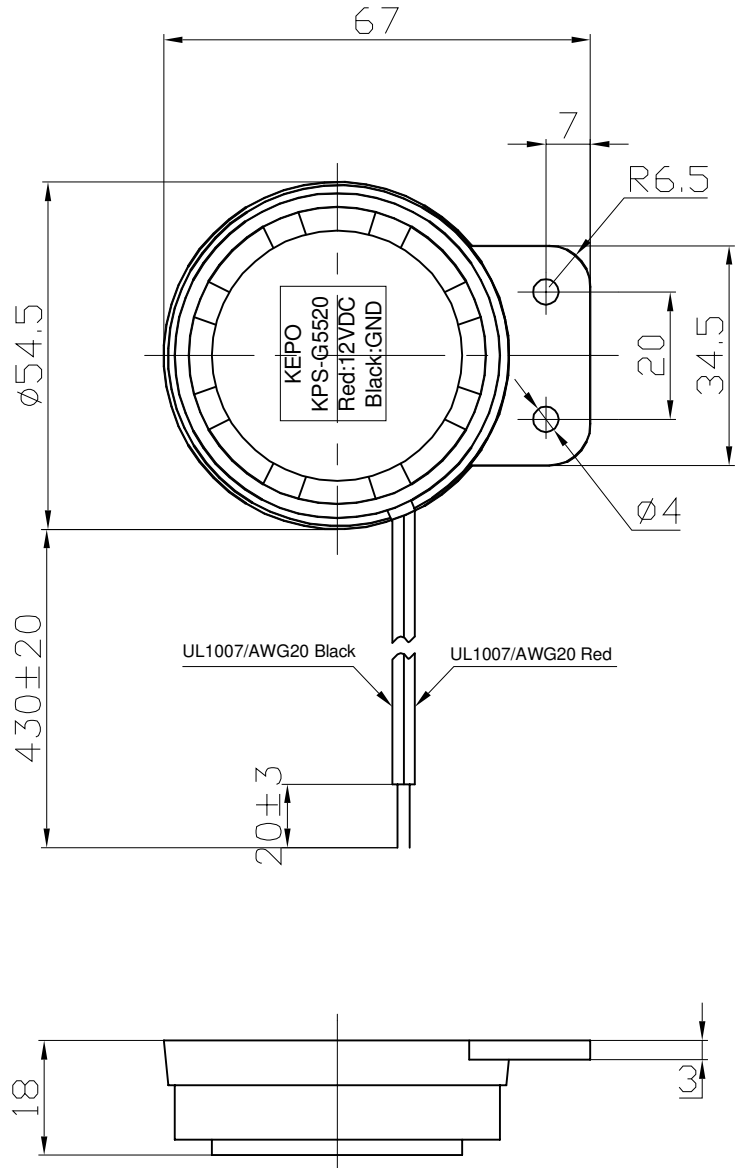

FIRST ANGLE PROJECTION

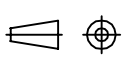

UNIT : mm
Tolerance : ± 0.5

Specification for Piezo Siren	Page	8/9
	Revision No.	1.0
Model No. : KPS-G5520-K1206	Drawing No.	KTC1206R

8. Packing

Specification for Piezo Siren	Page	9/9
	Revision No.	1.0
	Drawing No.	KTC1206R

Model No. : KPS-G5520-K1206

9. Revision

Rev. No.	DATE	PAGE	DESCRIPTION	SIGN
1.0	2013.04.03	/	primary	