

汽车继电器

TRFM

- Max.switching current 25A
- Different terminals available
- Conform to RoHS,ELV directive



■ ORDERING CODE 订购代码

<u>TRFM</u>	<u>D</u>	<u>12V</u>	<u>F</u>	<u>H</u>	<u>R1</u>
1	2	3	4	5	6
1. Relay Model 继电器型号				H: Form 1A	
2. Coil Power 线圈功率 D=1.6W, L=1.2W				Z: Form 1C	
3. Coil Nominal Voltage 线圈额定电压 6,12,24VDC				6. Coil transient suppression 线圈浪涌抑制 Blank(空白): Standard (标准)	
4. Encapsulation mode 封装方式 S: Sealed type 密封型 F: Flux tight 防尘型				R1: Coil parallel with 1/2W resistor 180Ω for Coil voltage 6VDC Coil parallel with 1/2W resistor 680Ω for Coil voltage 12VDC Coil parallel with 1/2W resistor 2700Ω for Coil voltage 24VDC	
5. Contact arrangement 触点形式				D1: Coil parallel with diode 1N4148 the positive pole "+" on #1 terminal D2: Coil parallel with diode 1N4148 the positive pole "+" on #2 terminal	

■ COIL DATA 线圈参数 (at 20°C)

Nominal Voltage 额定电压(VDC)	6	12	24	1.2W
Coil Resistance 线圈阻值(Ω)	30	120	480	
Rated Current 额定电流(mA)	200	100	50	
Max Operate Voltage 最大吸合电压(VDC)	3.9	7.8	15.6	
Min Release Voltage 最小释放电压(VDC)	0.3	0.6	1.2	
Coil Resistance 线圈阻值(Ω)	23	90	360	1.6W
Rated Current 额定电流(mA)	261	133	67	
Max Operate Voltage 最大吸合电压(VDC)	3.9	7.8	15.6	
Min Release Voltage 最小释放电压(VDC)	0.3	0.6	1.2	
Max Applicable Voltage 最大过载电压	70°C时额定电压的130%, 23°C时额定电压的170%			

■ CONTACT DATA 触点参数

Contact Form 触点形式	1H/1Z
Contact Material 触点材料	Silver Alloy
Load 负载	Resistive load(COS Φ 1)
Contact Ratings 触点负载	1H: 25A 14VDC 1Z: 20A 14VDC
Max Switching Voltage 最大转换电压	24VDC
Max Switching Current 最大转换电流	25A
Max Switching Power 最大转换功率	350W

Contact Resistance接触电阻	50mΩ Max at 6VDC 1A
Life Expectancy寿命	Electrical 电气寿命: 100,000 Operations(at30Operations/minute)
	Mechanical机械寿命: 10,000,000 Operations(at300Operations/minute)

■CENTACT DATA 一般参数

Insulation Resistance绝缘阻值	100MΩ Min at 500VDC
Dielectric Strength Between Open Contacts触点间耐压	500VAC(for one minute)
Between Contacts and coil触点与线圈间耐压	1000VAC(for one minute)
Operate Time吸合时间	10ms
Release Time释放时间	10ms
Temperature Range环境温度	-40℃to+85℃
Shock Resistance冲击	Operating Extremes动作极限: 10G
	Damage Limits破坏极限: 100G
Vibration Resistance振动	10-55Hz, 1.5mm
Max. switching frequency最大转换频率	Mechanical: 18,000 operations/hr
	Electrical: 1,800 operations/hr
Humidity湿度	85% (at 40℃)
Weight重量	Approx 18g
Safety Standard安全标准	

■ENGINEERING DATA 设计参数

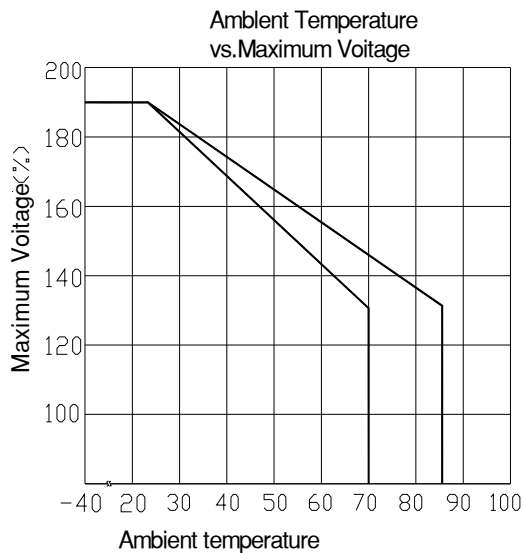
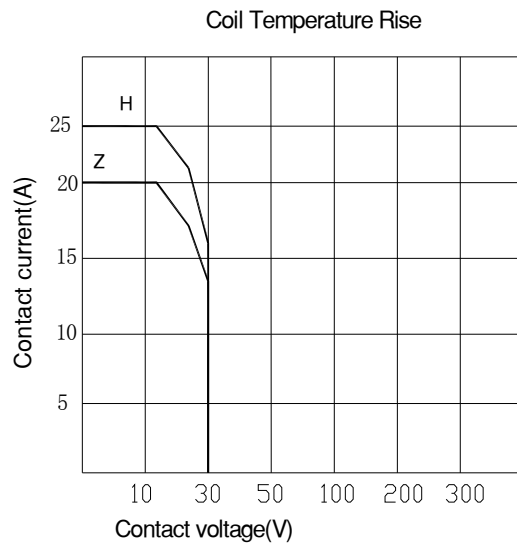
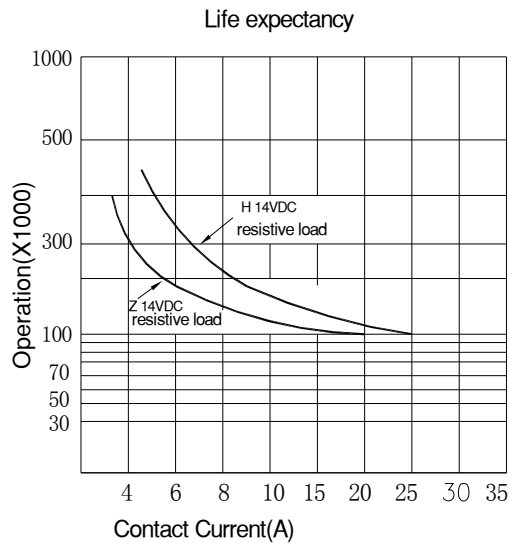

■ OVERALL AND MOUNTING DIMENSIONS 外形图及安装图

外形图

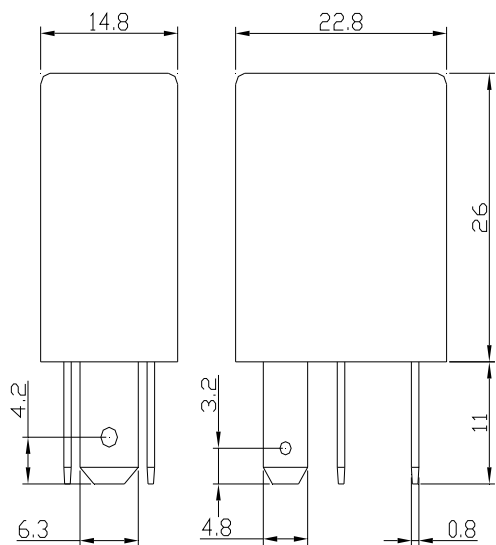

电阻（二极管）接线图

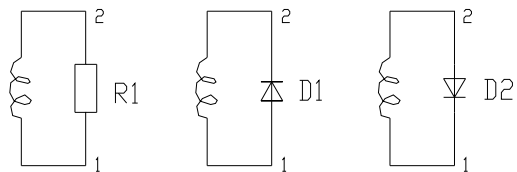

A 型安装图(快接式)

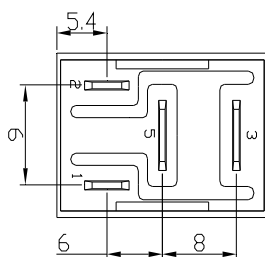

A 型接线图

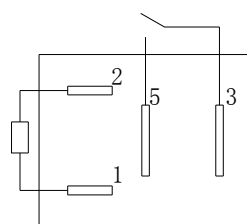

C 型安装图(快接式)

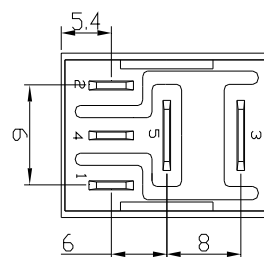

C 型接线图

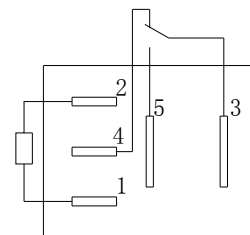

备注：1) 产品部分外形尺寸中未注尺寸公差：当外形尺寸 $\leq 1\text{mm}$ 时，公差为 $\pm 0.2\text{mm}$ ；当外形尺寸在 $1\sim 5\text{mm}$ 时，公差为 $\pm 0.3\text{mm}$ ；
当外形尺寸 $> 5\text{mm}$ 时，公差为 $\pm 0.4\text{mm}$ 。
2) 安装孔尺寸中未注尺寸公差均为 $\pm 0.1\text{mm}$ 。

声明：

本产品规格书仅供客户使用时参考，如有更改，恕不另行通知。