

## Miniature Rocker and Lever handle Switch

**Q-9257**

TYPE: **RLS-213-F**

### SPECIFICATIONS

Rating: 6A 125V AC; 3A 250V AC  
 Contact R: 20mΩ max  
 Insulation R: 500V DC 100MΩ min  
 Dielectric Strength: 1 Minute 1500V AC  
 Operating Temperature: -25°C ~ +85°C  
 Electrical Life: 10, 000 Cycles

Outline Drawing

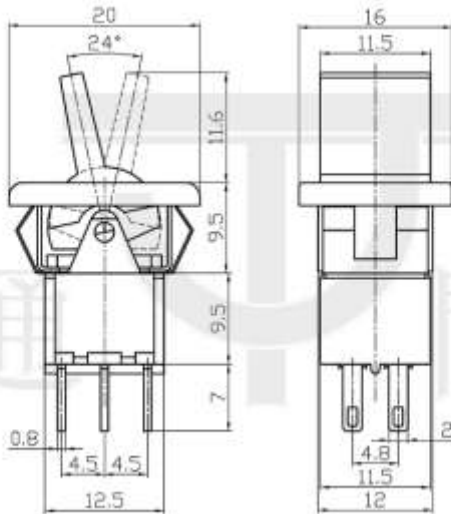

Mounting



Circuitry

