

Требования к окружающей среде

Температура окружающей среды -55 °C - + 100 °C

относительная влажность воздуха + 40 °C, 93%

1 кПа атмосферное давление

Вибрация: 10-2000ZН, 150м / S2

ускорение: 490m / s2

Постоянное ускорение вибрации "" 245m / s2

Сопротивление изоляции: ≥5000MΩ

Номинальное напряжение: 400В

Выдерживаемое напряжение: 1000В

Время жизни: 500

IP67



FQ

Внешние размеры
прямой пружиными

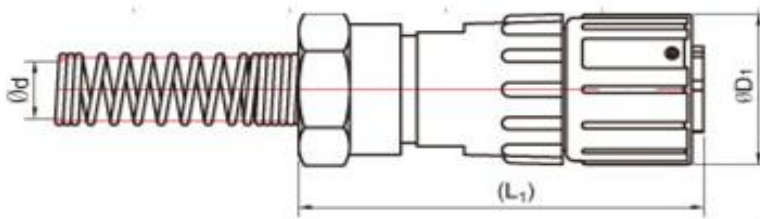

	ØD ₁	L ₁	Ød
FQ14	Ø21	47/50	Ø5/Ø6, 07/Ø8
FQ18	Ø27	53	Ø6, 08, 09, 010
FQ24	Ø33	61	Ø6, 010, 012, 014
FQ30	Ø39	68	Ø14, 016, 018

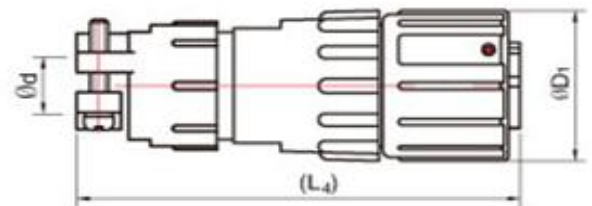

	ØD ₁	L ₄	Ød
FQ14	Ø21	56	Ø6, 07, 08
FQ18	Ø27	59	Ø6, 08, 09, 010
FQ24	Ø33	66	Ø6, 010, 012, 014
FQ30	Ø39	74	Ø14, 016, 018

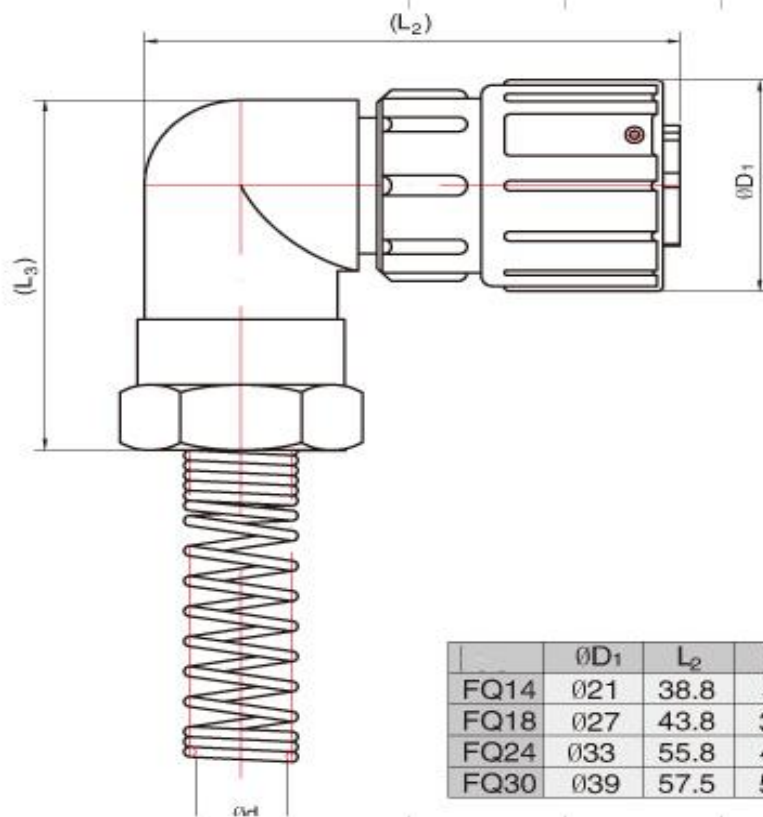

	ØD ₁	L ₂	L ₃	Ød
FQ14	Ø21	38.8	37	Ø6, 07, 08
FQ18	Ø27	43.8	38	Ø6, 08, 09, 010
FQ24	Ø33	55.8	45	Ø6, 010, 012, 014
FQ30	Ø39	57.5	50	Ø14, 016, 018

Square Flange Receptacle

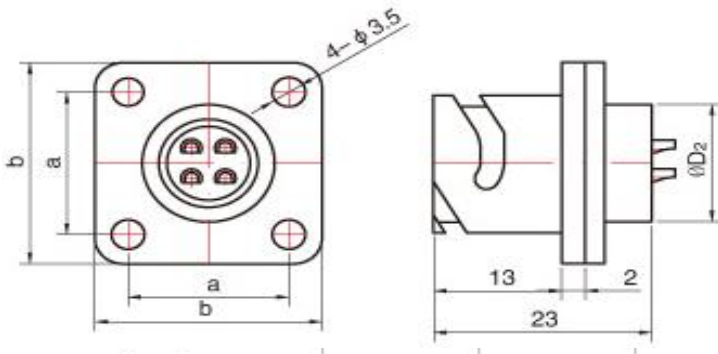

Mounting Dimensions

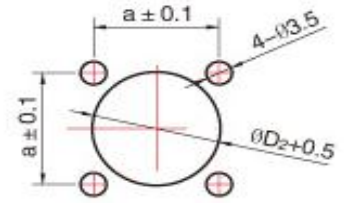

Circular Receptacle:

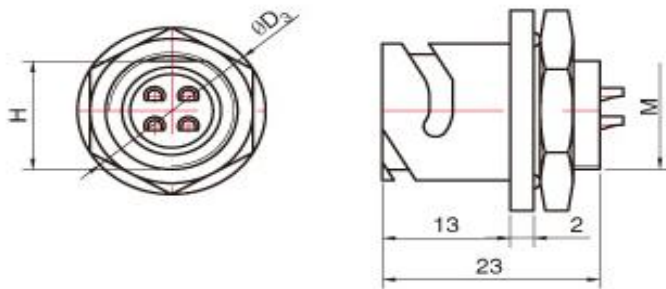

Mounting Dimensions:

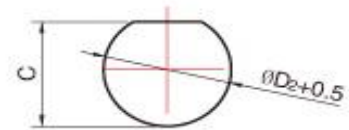

	φD ₃	M	φD ₂	H	C
FQ14	φ19.7	M14 × 1	φ14	13	13.2
FQ18	φ23.8	M18 × 1	φ18	17	17.2
FQ24	φ30	M24 × 1	φ24	23	23.2
FQ30	φ36	M30 × 1	φ30	29	29.2

Spring Cable Receptacle

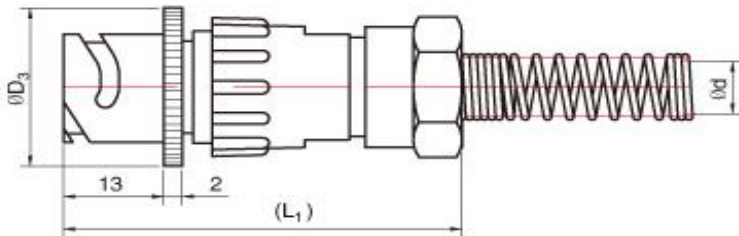

: Waterproof Cable Receptacle

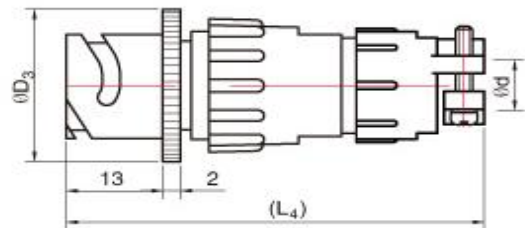

	φD ₃	L ₁	φd
FQ14	φ19.7	47/50	φ5/φ6、φ7/φ8
FQ18	φ23.8	53	φ6、φ8、φ9、φ10
FQ24	φ30	61	φ6、φ10、φ12、φ14
FQ30	φ36	68	φ14、φ16、φ18

类型	φD ₃	L ₄	φd
FQ14	φ19.7	56	φ6、φ7/φ8
FQ18	φ23.8	59	φ6、φ8、φ9、φ10
FQ24	φ30	67	φ6、φ10、φ12、φ14
FQ30	φ36	74	φ14、φ16、φ18

Plastic Dustproof cover

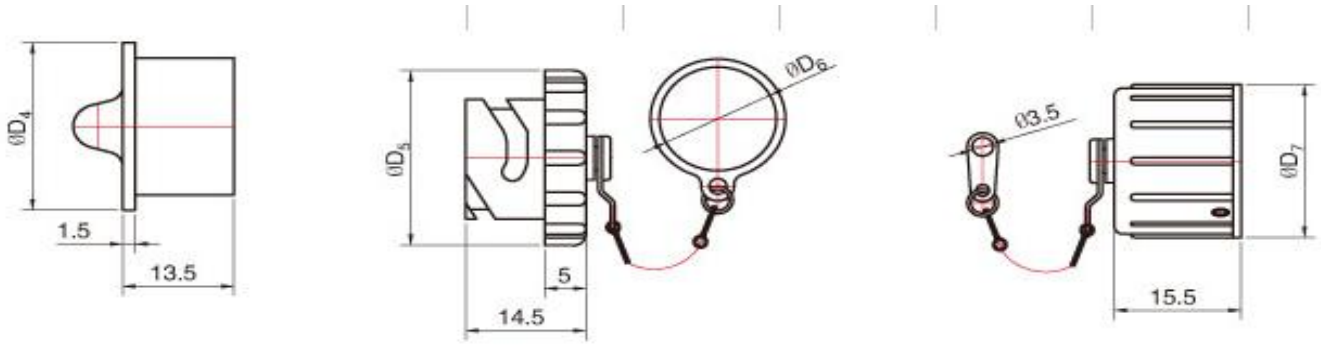

	$\varnothing D_4$	$\varnothing D_5$	$\varnothing D_6$	$\varnothing D_7$
FQ14	023	023	013.2/014.2/016.2	021
FQ18	028	028	016.2	026
FQ24	034	034	022.2	033
FQ30	040	040	026.2	039

● — 00.8

⊙ — 01

◐ — 01.5

◑ — 02.5



FQ14-2



FQ14-3



FQ14-3T



FQ14-4

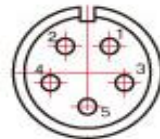

FQ14-5



FQ14-6



FQ14-7



FQ14-8



FQ14-9



FQ18-2



FQ18-3



FQ18-4



FQ18-5

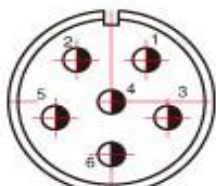

FQ18-6

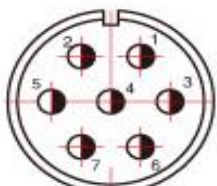

FQ18-7



FQ18-12



FQ24-4

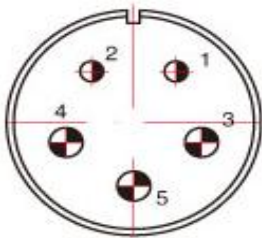

FQ24-5

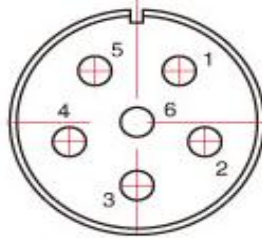

FQ24-6

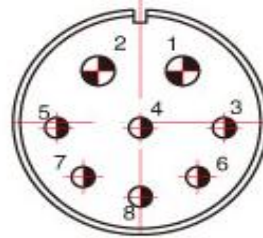

FQ24-8



FQ24-8T

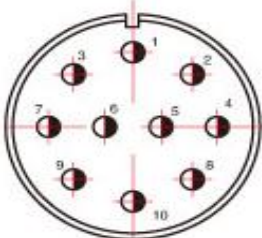

FQ24-10

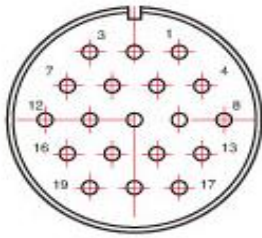

FQ24-19

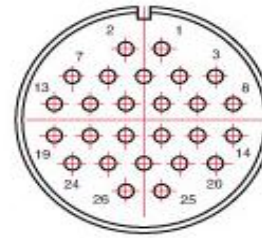

FQ24-26

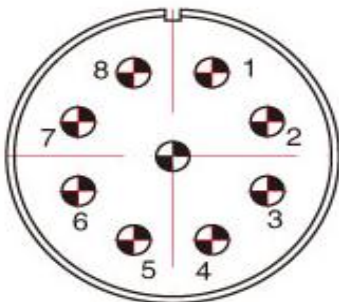

FQ30-9

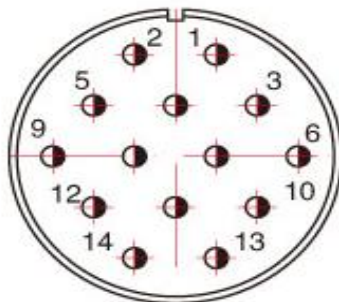

FQ30-14

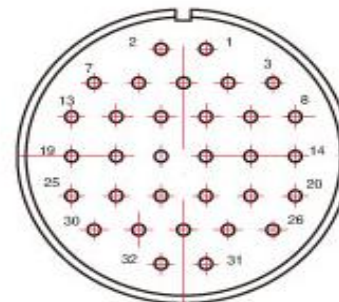

FQ30-32

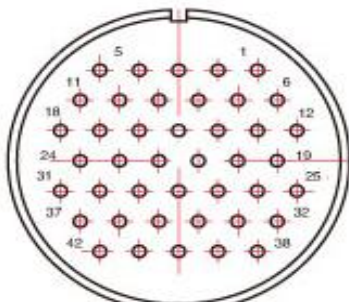

FQ30-42

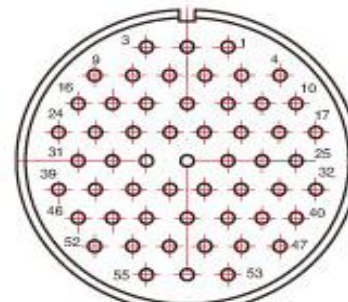

FQ30-55