

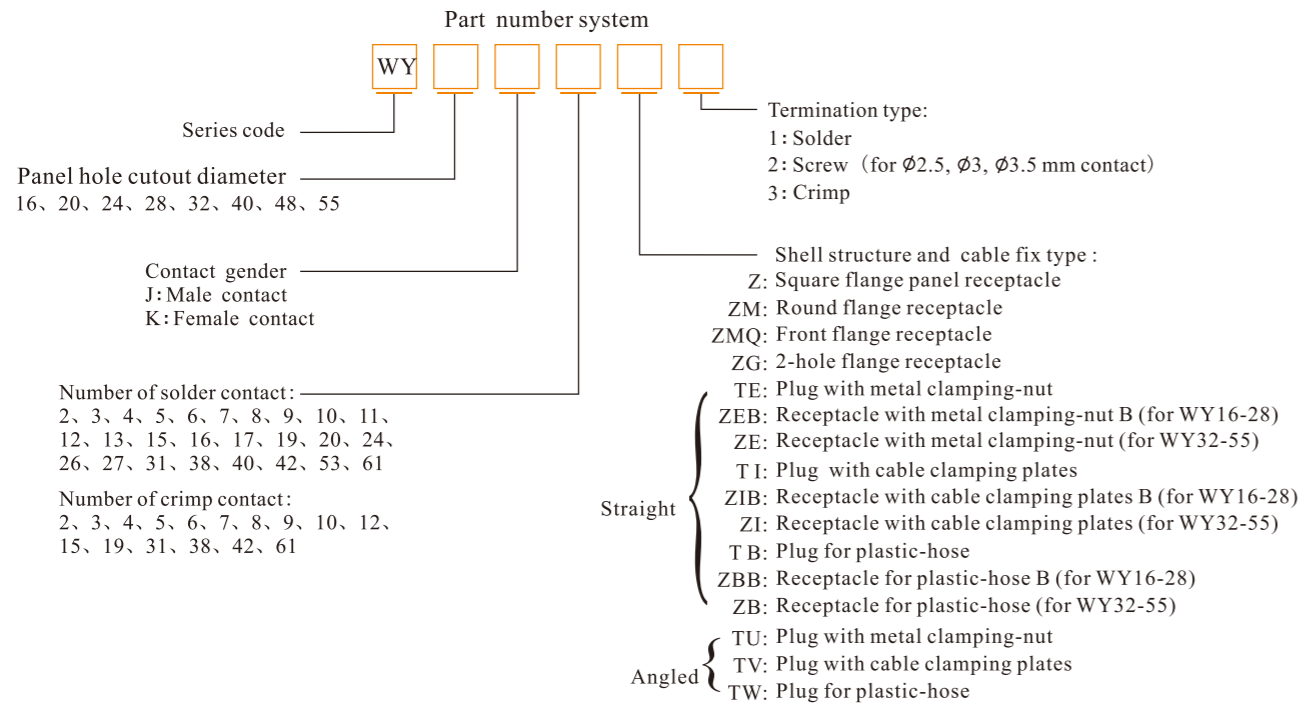

WY Series



Remarks : The rated current decreases according to the number of contacts, more contacts, less rated current.

Number of contact	1-3	4-10	11-20	21-30	31-40	41-50	51-61
Rated current decrease rate (%)	0	10	20	30	40	50	60

★ Each side can be male or female contact ★ Solder contact spec see page 105-106
 ★ Crimp contact spec see page 107-110 ★ Screw contact spec see page 111-112

Material and spec	
Coupling	Bayonet
Shell material	Zinc alloy with chrome plating
Insert material	PPS, max temperature 260 °C
Contact material	Brass with gold plating
Termination	Solder: $\phi 1, \phi 1.5, \phi 2.5, \phi 3.5, \phi 5, 5$ mm; Screw: $\phi 2.5, \phi 3, \phi 3.5$ mm; Crimp: $\phi 1, \phi 1.5, \phi 2.5, \phi 3.5, \phi 5.5, \phi 10$ mm
Mating cycle	500
Temperature range	-40°C ~ +85°C

WY Series Mating diagram

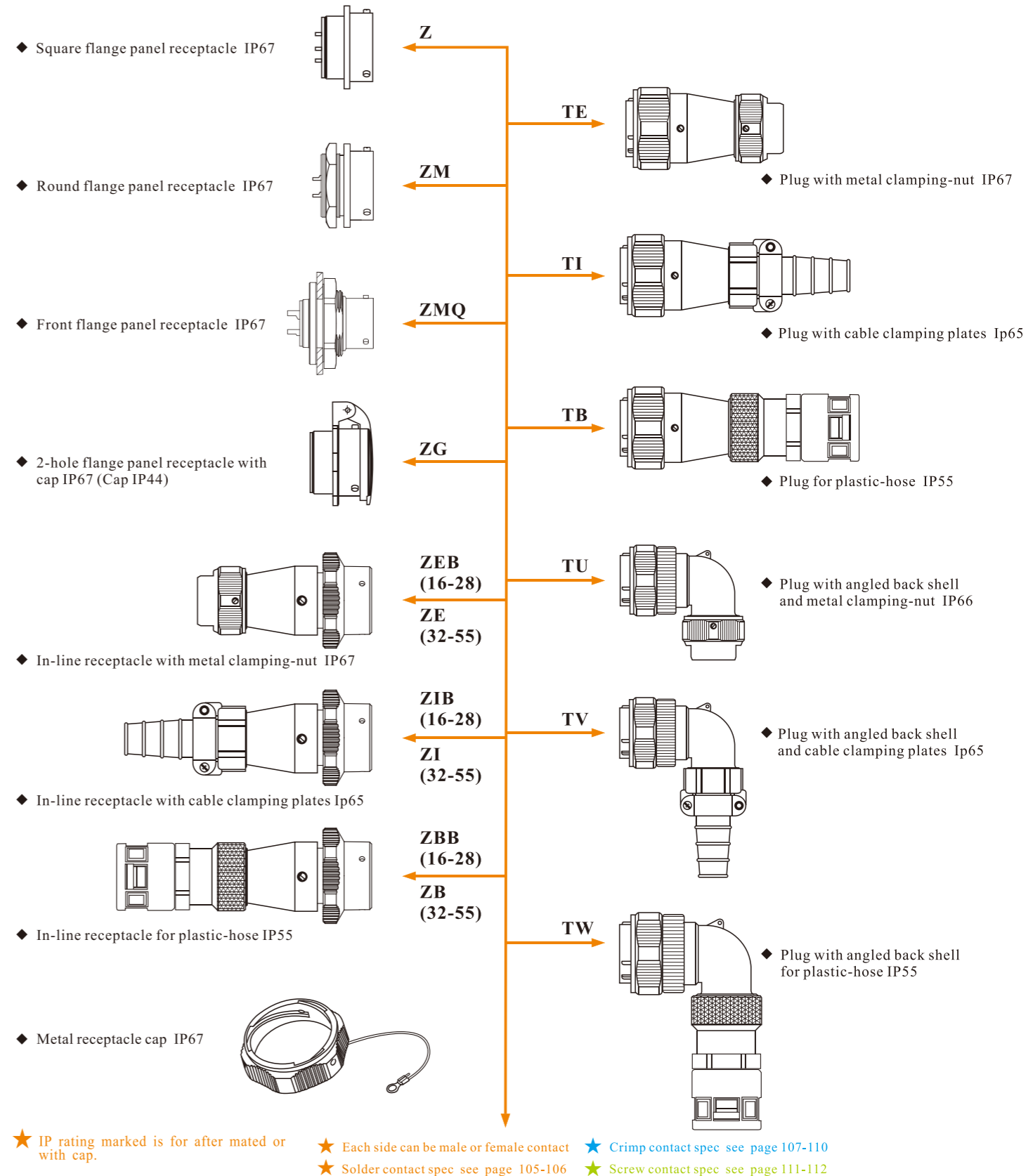

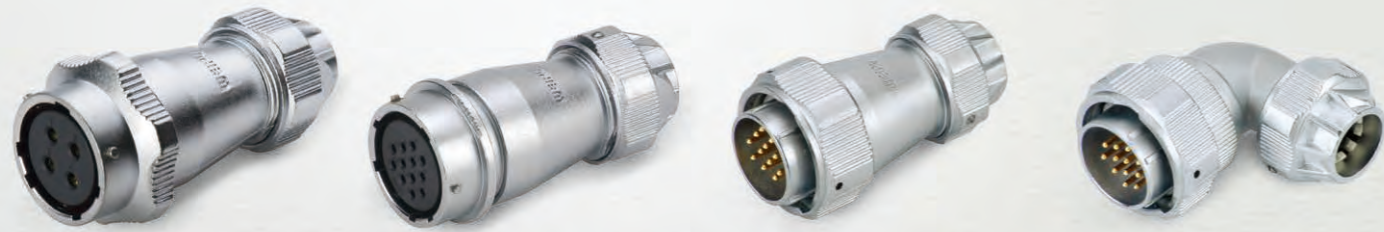

● In-line receptacle with metal clamping-nut B: ZEB IP67

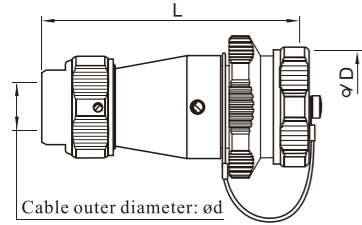

Dimension(mm)	WY16	WY20	WY24	WY28
D	18	22	26	30
L	55	63	66.5	70
ød	5-6.5	9-10.5	9-10.5	10.5-12.5

Optional cap size see P101

● In-line receptacle with metal clamping-nut: ZE IP67

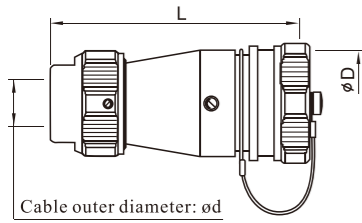

Dimension(mm)	WY32	WY40	WY48	WY55
D	35	44	52	59
L	90.5	103.5	108	131.6
ød	15.5-17	18-20	I:18-20 II:24.5-26	24.5-26

Optional cap size see P101

● Plug with metal clamping-nut: TE IP67

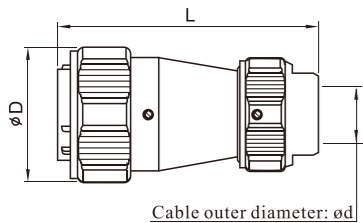

Dimension(mm)	WY16	WY20	WY24	WY28	WY32	WY40	WY48	WY55
D	25	29.5	34	38.5	44.5	54	62	68.5
L	54.5	62.5	65	68	88	100	110	131.5
ød	5-6.5	9-10.5	9-10.5	10.5-12.5	15.5-17	18-20	I:18-20 II:24.5-26	24.5-26

● Plug with angled back shell and metal clamping-nut: TU IP66

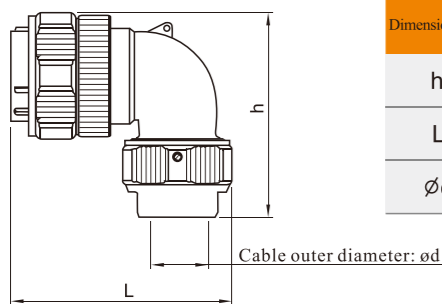

Dimension(mm)	WY16	WY20	WY24	WY28	WY32	WY40	WY48	WY55
h	43	53	54	58	72	88	103	110.5
L	48	57	59	61	84	90	97	109
ød	5-6.5	9-10.5	9-10.5	10.5-12.5	15.5-17	18-20	24.5-26	24.5-26



● In-line receptacle with cable clamping plates B: ZIB IP65

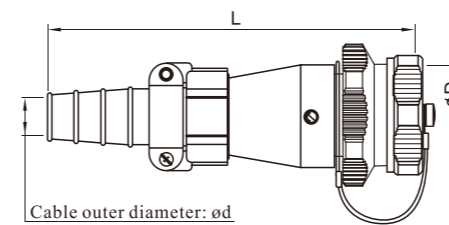

Dimension(mm)	WY16	WY20	WY24	WY28
D	18	21.5	25.5	29.5
L	73	88	92	101
ød	7-8	8-10.5	8-10.5	11.5-13.6

Optional cap size see P101

● In-line receptacle with cable clamping plates: ZI IP65

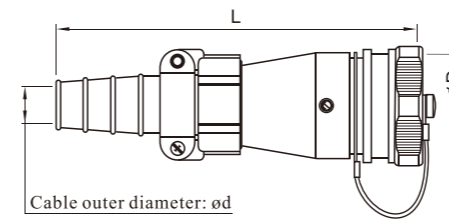

Dimension(mm)	WY32	WY40	WY48	WY55
D	34.5	43.5	51.5	58
L	119	130	137	165
ød	13-15.6	15.5-18.8	I:15.5-18.8 II:24-28	24-28

Optional cap size see P101

● Plug with cable clamping plates: TI IP65

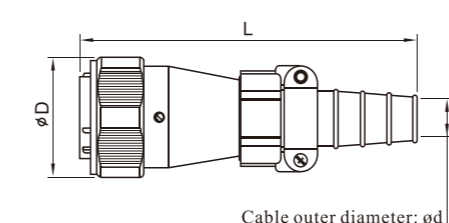





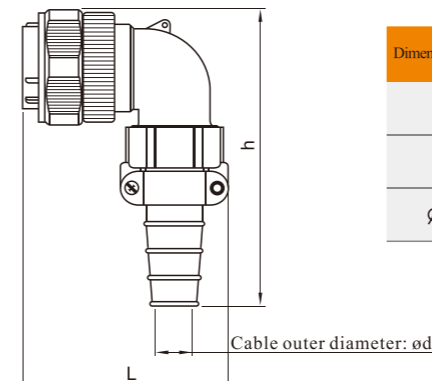





Dimension(mm)	WY16	WY20	WY24	WY28	WY32	WY40	WY48	WY55
D	25	29.5	34	38.5	44.5	54	62	68.5
L	72.5	87	92	100.5	48.5	130.5	140	163
ød	7-8	8-10.5	8-10.5	11.5-13.6	13-15.6	15.5-18.8	I:15.5-18.8 II:24-28	24-28

● Plug with angled back shell and cable clamping plates: TV IP65



Dimension(mm)	WY16	WY20	WY24	WY28	WY32	WY40	WY48	WY55
h	60	80	80	93	103	118	137	140
L	49.5	56.5	58	61	82.5	90	98	108
ød	7-8	8-10.5	8-10.5	11.5-13.6	13-15.6	15.5-18.8	24-28	24-28

Solder contact spec

WS16、WF16、WY16	2	3	4	2B	3B	4B	5	7	9	10
Male contact face view										
Rated current (A)	10	10	5	15	15	15	5	5	5	5
Contact diameter(mm)	∅1.5X2	∅1.5X3	∅1X4	∅2X2	∅2X3	∅2X4	∅1X5	∅1X7	∅1X9	∅1X10
Rated voltage (AC.V)	500	500	500	500	500	500	500	400	400	400
Test voltage(AC.V) 1 min	1500	1500	1500	1500	1500	1500	1500	1200	1200	1200
Contact resistance(mΩ)	2.5	2.5	5	2.5	2.5	2.5	5	5	5	5
Insulation resistance (MΩ)	2000	2000	2000	2000	2000	2000	2000	2000	2000	2000
Wire size (mm ² /AWG)	≤2/14	≤2/14	≤0.75/18	≤2/14	≤2/14	≤2/14	≤0.75/18	≤0.75/18	≤0.75/18	≤0.75/18