

Circuit	Dimensions(mm)	
	A	B
02	1.25	4.25
03	2.50	5.50
04	3.75	6.75
05	5.00	8.00
06	6.25	9.25
07	7.50	10.50
08	8.75	11.75
09	10.00	13.00
10	11.25	14.25
11	12.50	15.50
12	13.75	16.75
13	15.00	18.00
14	16.25	19.25
15	17.50	20.50
16	18.75	21.75
--	---	---
25	30.00	33.00

Material:
Housing:PA66(UL 94V-0/V-2),White
Contacts:Phosphor Bronze,Tin Plated

- Electrical Characteristics:**
- 1.Poles: 2 to 25P
 - 2.Current rating: 1.0A
 - 3.Voltage rating: 125V
 - 4.Temperature range: -25°C to +85°C
 - 5.Contact resistance: $\leq 20m\Omega$
 - 6.Insulation resistance: $\geq 100M\Omega$
 - 7.Withstand voltage: 500V AC/minute
 - 8.Applicable wire: AWG #32 to #28
 - 9.Applicable PC board thickness: 0.8mm

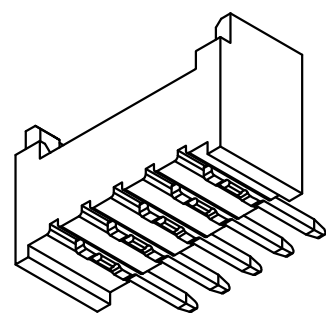
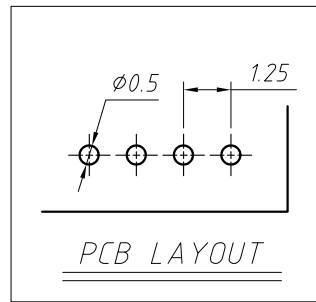
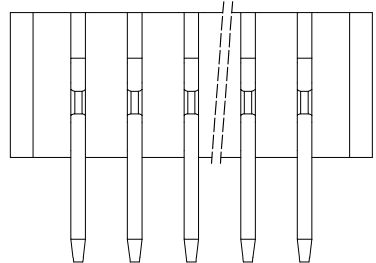

Order Information

L-KLS1-XL1-1.25-XX-R

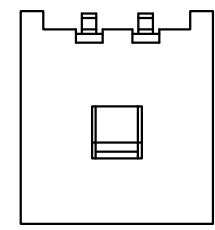
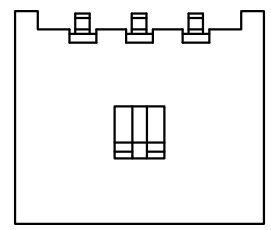
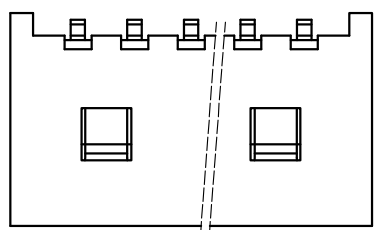
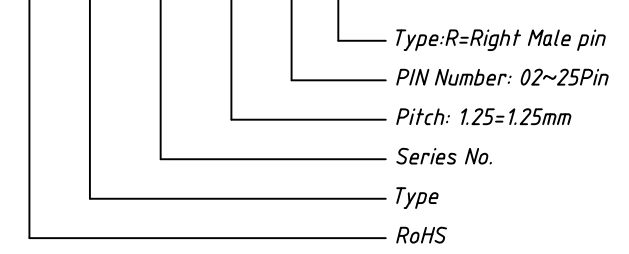

GENERAL TOLERANCE	PROJECTION		Description:
X. ± 0.50	UNITS	mm	1.25mm ZH Type Wire To Board Connector
.X ± 0.25	SCALE	1:1	
.XX ± 0.10	Draw by:	Jenny	
ANGLE TOLERANCE	Check by:		KLS P/N: L-KLS1-XL1-1.25-XX-R
X. $\pm 5^\circ$	Date	2018-03-01	NingBo KLS ELECTRONIC CO.,L TD.
.X $\pm 3^\circ$	SHEET	1 OF 1	
.XX $\pm 2^\circ$			