

BOM LIST			
ITEM	PART NAME	Q'ty	NOTES
1	PLASTIC HOOD	2	ABS
2	2.1 LONG BOLT	2	#4-40
	2.2 SHORT BOLT	2	#4-40
3	NUT	2	M3
4	LONG SCREW	2	M3
5	SMALL WASHER	2	
6	SHORT SCREW	2	M3
7	7.1 METAL WASHER	2	M3
	7.2 PLASTIC-1 WASHER	2	ABS
	7.3 PLASTIC-2 WASHER	2	ABS

REV.	DESCRIPTION	DRAWN	CHECKED	APPROVED
A	NEW RELEASE	LJH 08/13/05'	~	LJC 08/13/05'
B	整理图面	YCH 09/13/07'	~	

DSUB PLASTIC CASE (DP-9C)

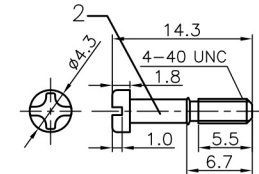
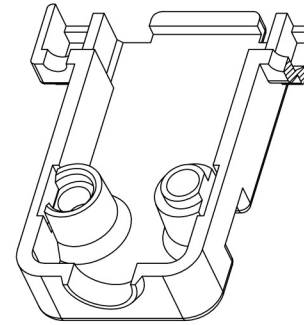
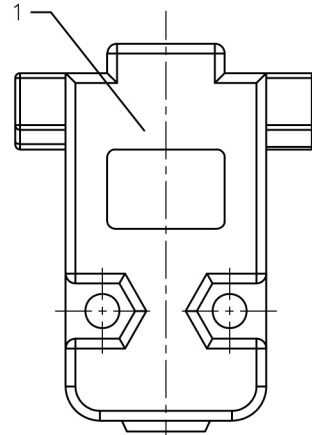
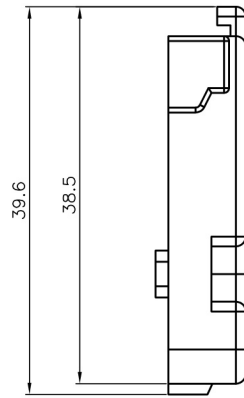
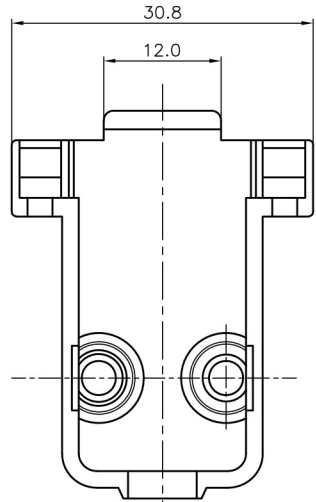
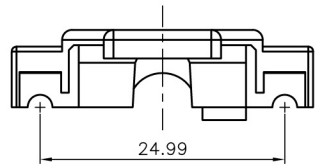

Short BOLT

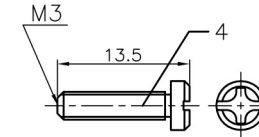

LONG SCREW

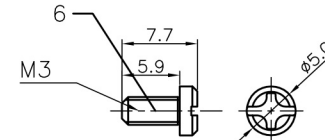

SHORT SCREW

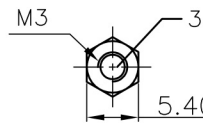

UNT t=2.3mm

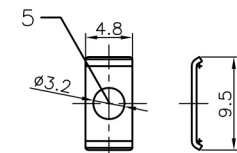

SMALL WASHER

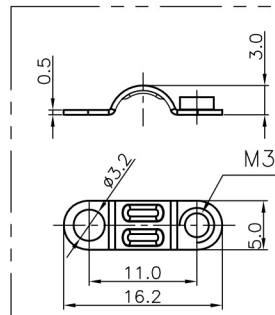
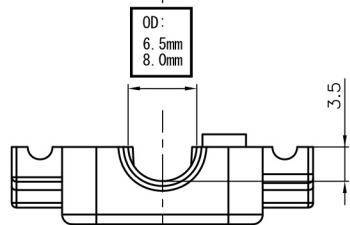

Metal

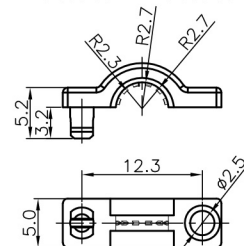

Plastic-1

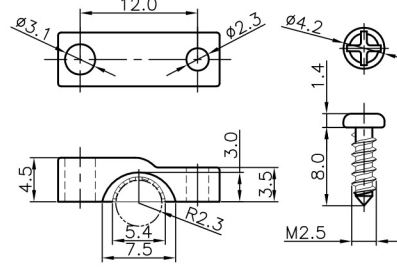

Plastic-2

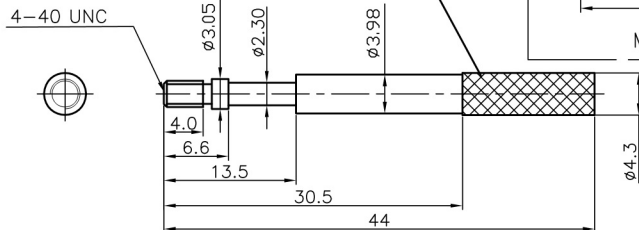

Long BOLT

GENERAL TOLERANCE		ANGLE TOLERANCE		PROJECTION	TITLE
X. ±0.60	.X ±0.38	.X ±5°	.X ±3°	mm	
.XX ±0.25		.XX ±2°		SHEET SIZE	A4
DRAWING TYPE		COSTOMER		SERIES	DS1046 SERIES
SCALE		1:1		RUI CHI	
DRAWING NO.		C-DS1046-09XXXX			